



ADDAC System
Instruments for Sonic Expression
Est.2009



INTRODUCING
ADDAC511
VC STOCHASTIC
VOLTAGE
GENERATOR

USER'S GUIDE . REV01
December.2024

FIRMWARE 1.0



From Portugal with Love!

Welcome to:

ADDAC511 VC STOCHASTIC

VOLTAGE GENERATOR

USER'S GUIDE

Revision.01 December.2024

PAGE INDEX

- 3. **INTRO & FEATURES**
- 4. **SIGNAL FLOW DIAGRAM**
- 5. **FRONT PANEL LAYOUT**
- 6. **OLED SCREEN**
- 7. **BUTTONS LONG PRESSES**
- 9. **STATES**
- 10. **MODES**

VOLTAGE MODE

VOLTAGE SETTINGS

- 11. **OVERVIEW**
- 12. **VOLTAGE SETTINGS**
- 13. **VOLTAGE & GATE OUT**
- 16. **VOLTAGE PROBABILITY**
- 17. **VOLTAGE & TIME DISTRIBUTION**
- 18. **SMOOTH INTERPOLATION**
- 19. **STEPPED INTERPOLATION**

TIME SETTINGS

- 20. **OVERVIEW**
- 21. **TIME SETTINGS**
- 23. **CLOCK**
- 24. **CLOCK MASTER/SLAVE**
- 25. **CLOCK FOLLOW**
- 26. **CLOCK DELAY**
- 28. **CLOCK EXAMPLES**

- 29. **LOCK**

ENVELOPE MODE

ENVELOPE SETTINGS

- 32. **OVERVIEW**
- 33. **ENVELOPE SETTINGS**
- 36. **ENVELOPE QUANTIZER**

TIME SETTINGS

- 37. **OVERVIEW**
- 38. **TIME SETTINGS**
- 39. **CLOCK**

QUANTIZER

QUANTIZER

- 40. **QUANTIZER OVERVIEW**
- 41. **INTERNAL/EXTERNAL QUANTIZATION**
- 42. **QUANTIZER SOURCES**
- 43. **ROUNDING & NOTE PROBABILITY**
- 44. **QUANTIZER & SMOOTH**
- 45. **EXTERNAL QUANTIZATION**
- 46. **QUANTIZER TRANSPOSE**
- 47. **CHORD GENERATION EXAMPLE**

- 48. **PRESETS**
- 49. **CV ASSIGNS**
- 52. **LOGIC ASSIGNS**

- 56. **MENU**
- 58. **FIRMWARE UPDATES**
- 59. **SPECIAL START-UPS**

- 60. **PATCH EXAMPLES**

Welcome to: ADDAC511 VC STOCHASTIC VOLTAGE GENERATOR USER'S GUIDE

Revision.01 December.2024

Tech Specs:
20HP
4.5cm deep
200mA +12V
100mA -12V

WELCOME

At ADDAC System we love all sources of unpredictability be it by randomness or signal complexity. This module greatly expands on the principles of our ADDAC501 Complex Random from 2013. This is a fully fledged 4 channel voltage generator capable of all things random, with quantization, probability, distribution, interpolation, time control, clock, states and a 32 step sequencer.

The module operation relies on its screen for all parameter editing, each button accesses one single page where parameters can be changed allowing a fast and fluid workflow across all settings.

Long presses on all buttons have a secondary function allowing fast Channel selection plus Mute and Hold functions.

The combination of having 2 Encoders with Push buttons allow swift navigation and editing across all pages and their settings.

FEATURES

4 independent channels with bipolar CV / Gate outputs and Clock Input that allow all things random.

Each channel can be set to generate either continuous Voltages, Envelopes or as a Quantizer.

Mutes and Holds per channel
3 States per channel allow very fast settings changes, allowing from smooth to drastic transitions.

Controls over Voltage Range, Quantization with custom scales, Probability, Distribution curves and Smoothing, plus time and bpm ranges, time distribution curves and several clock sources.

A 32 step sequencer per channel that can work completely independent or in sync.

8 Assignable CV inputs and 4 Gate inputs can be internally mapped to any setting of any channel.

3 configurable Logic outputs allows complex logic events comparing different channel states.

Average CV output of all 4 CV outputs.

Easy VCO tuning available in the Menu.

Calibration and mapping of all 4 CV outputs is also allowed through the Menu

20HP

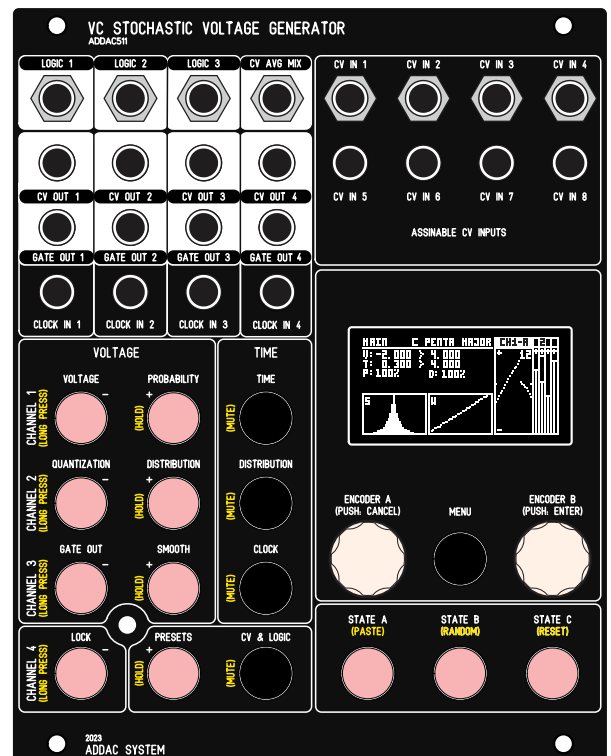

SIGNAL FLOW DIAGRAM

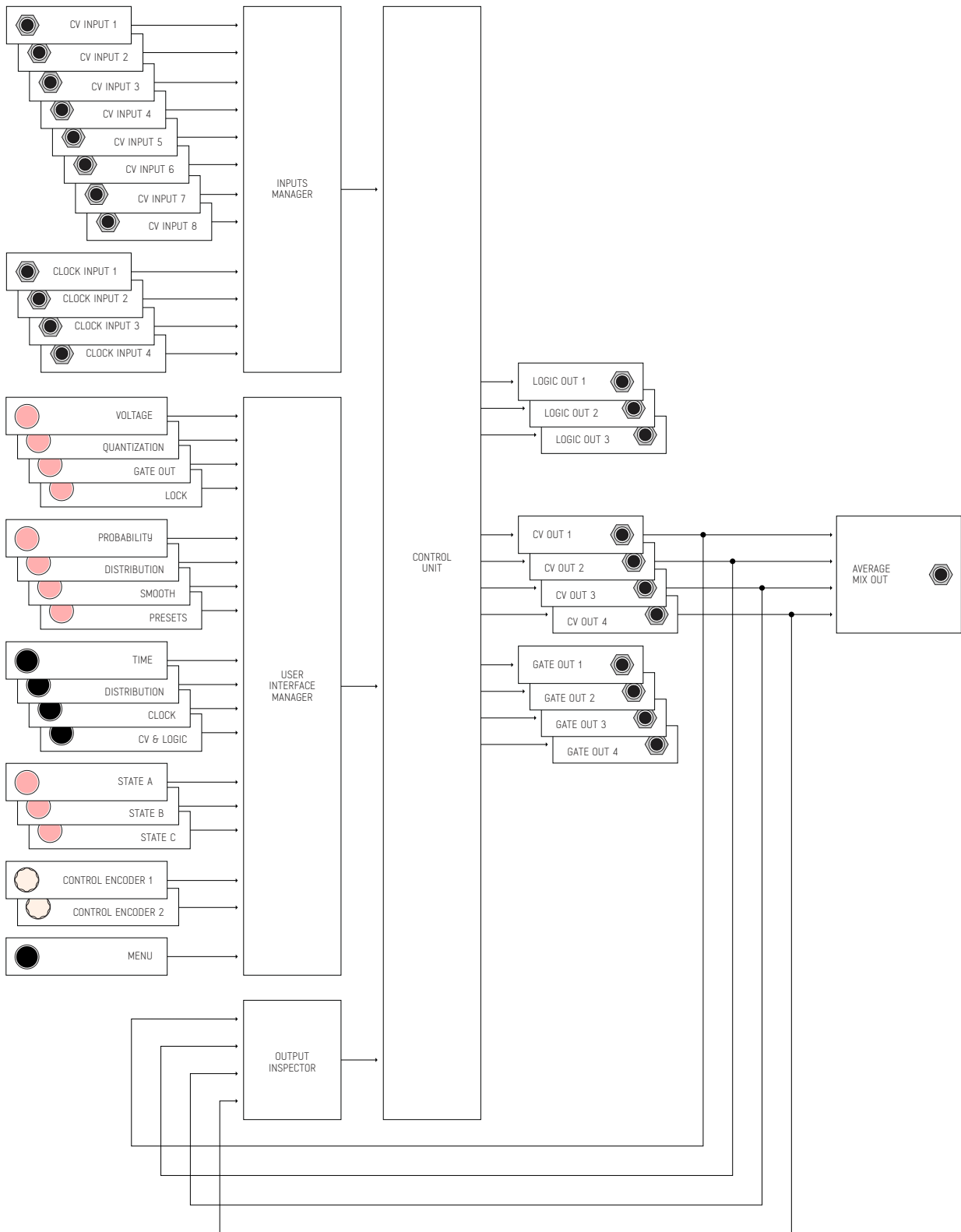

FRONT PANEL LAYOUT

There are several distinct sections in this module:

- LOGIC OUTPUTS: 3 configurable logic outputs
- CV OUTPUTS: 4 CV outputs
- GATE OUTPUTS: 4 Gate outputs
- CLOCK / GATE INPUTS: 4 Gate inputs
- VOLTAGE SETTINGS
- TIME SETTINGS

- AVERAGE MIX: CV output
- CV INPUTS: 8 CV inputs
- CONTROLS: Encoders & Menu
- STATES
- PRESETS & ASSIGNS
- LOCK / SEQUENCER

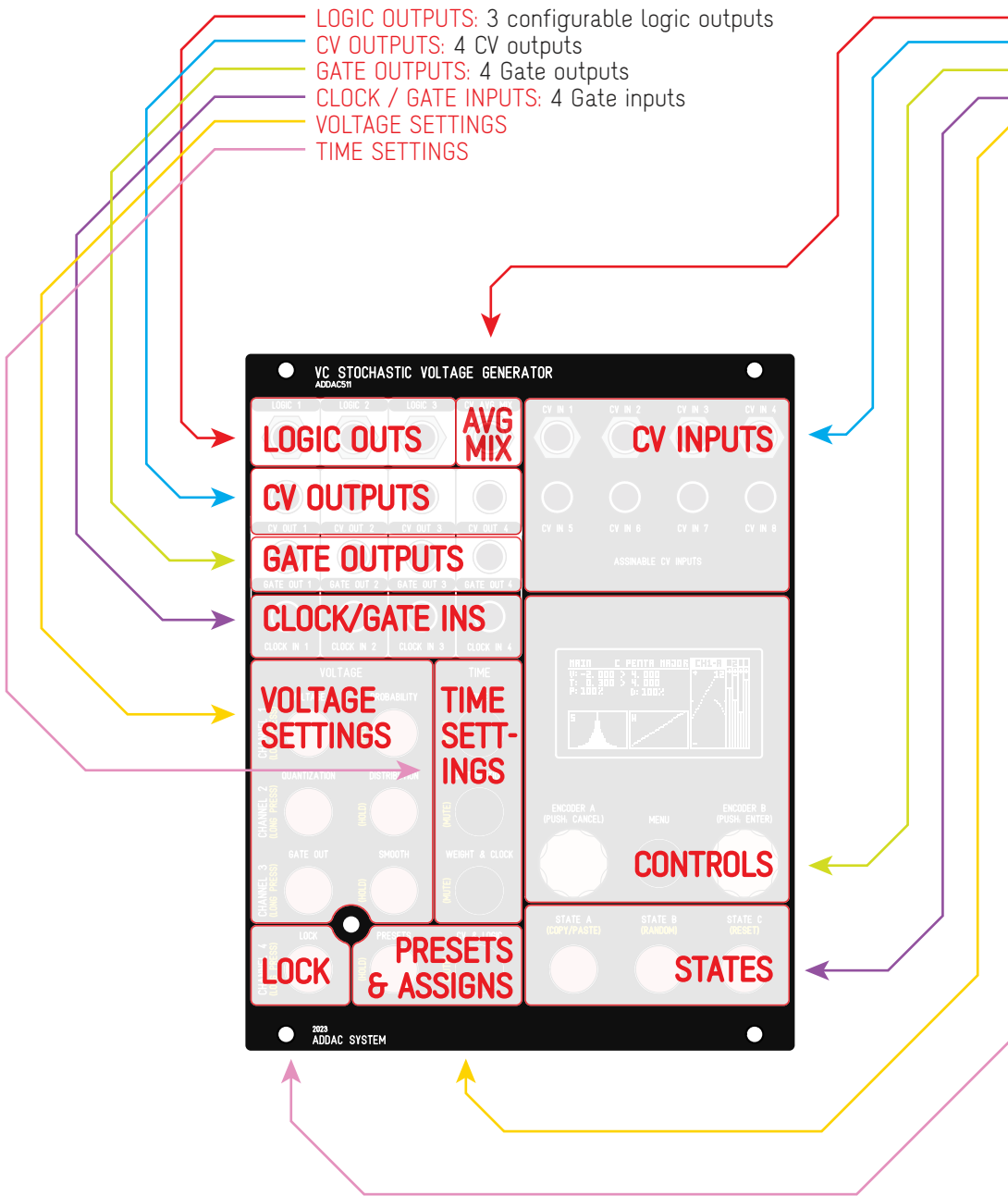

OLED MONITOR

MAIN SCREEN:

The Main Screen shows the most important info for overall operation.

CHANNELS GATES & SPECIAL STATES

Four top squares shows the 4 channels Gate Output state as well as special states:
O = Mute (0v), H = Hold

ACTIVE CHANNEL & STATE

Shows the active channel and state

SELECTED QUANTIZATION

Scale selected

SCREEN TITLE

Shows the Screen name

VOLTAGE SETTINGS

Minimum and Maximum voltage range

TIME SETTINGS

Minimum and Maximum time range

PROBABILITY & SMOOTH DURATION SETTINGS

Shows the Probability and

DISTRIBUTION CURVE

Low resolution representation of the waveform

WEIGHT CURVE

Grains envelope representation

SELECTED CHANNEL OSCILLOSCOPE

Shows the history and polarity of the selected channel.
Rotating Encoder 2 allows zooming in and out on the display buffer.

CHANNELS REAL TIME STATE

The current CV state of all 4 channels

POLARITY SETTING

Shows the polarity setting: + or ±

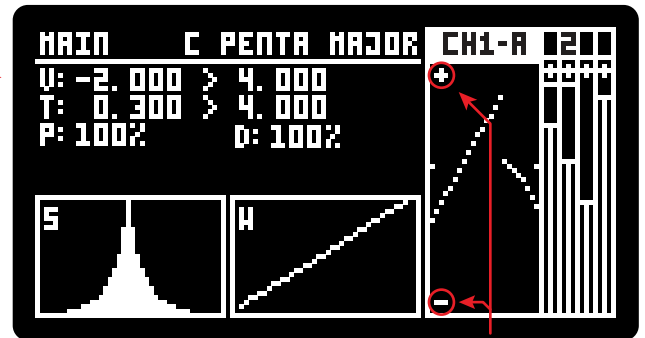

MAIN SCREEN ENCODER BEHAVIOUR

Rotating Encoder 1 selects shown values, Encoder 2 edits the settings.

Pressing Encoder 2 deselects any selected setting

Rotating Encoder 2 with no selected setting zooms in and out on the oscilloscope screen

LONG PRESSES CHANNEL SELECTION, HOLDS & MUTES

Every column of the main interface features a secondary function when pressed for over 1 second.

CHANNEL SELECTION

The first column selects the channel to be edited. The change can be seen at the top right corner as shown here

HOLD FUNCTION

The second column activates the Hold function which holds the CV output current value until the button is pressed again. When active the respective channel will display its state on the top right corner with the letter "H"

MUTE FUNCTION

The third column activates the Mute function which sets the CV output to 0v until the button is pressed again. When active the respective channel will display its state on the top right corner with the number "0".

Every row corresponds to a channel.

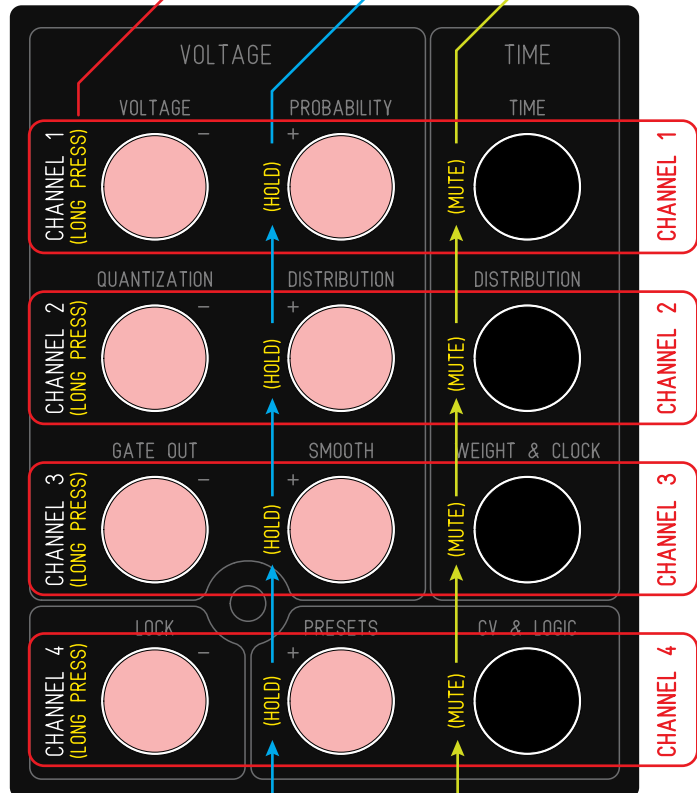
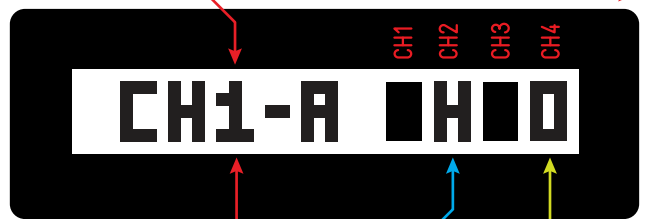
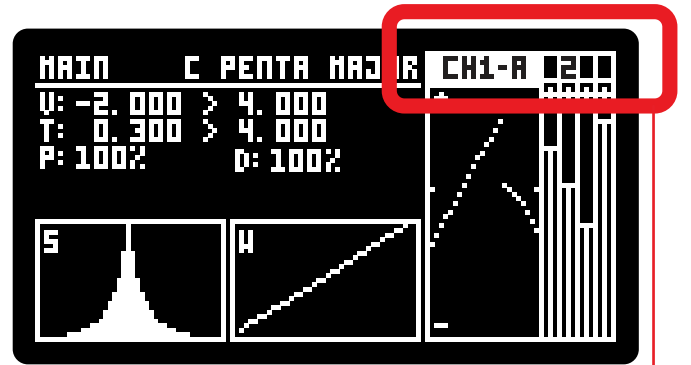

LONG PRESSES PASTE, RANDOM & RESET

The 3 State buttons have a secondary function when pressed for longer than 1 second.

STATE A - PASTE

A long press on this button enters the Copy screen. The Copy function is screen dependent meaning that will copy different settings depending on the screen state. It is also Channel and State dependent meaning every State of every Channel can be accessed as a block to be copied from.

If the screen is in Main then Copy will change all setting on the current Channel and State from the selection made on the Copy screen.

If the screen is in any other page, the copy function will only copy the settings of that particular page.

The Copy screen shows:

The current Channel and State

The current Screen page

The Channel from which to copy

The State from which to copy related to the channel selected above.

The two Encoders buttons choose between Cancel to exit the copy screen without making changes and Enter to execute the copy process.

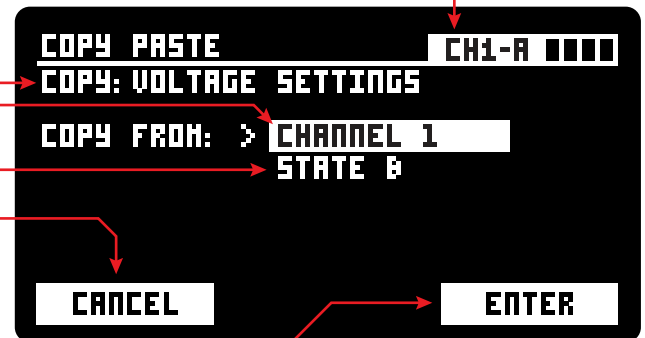
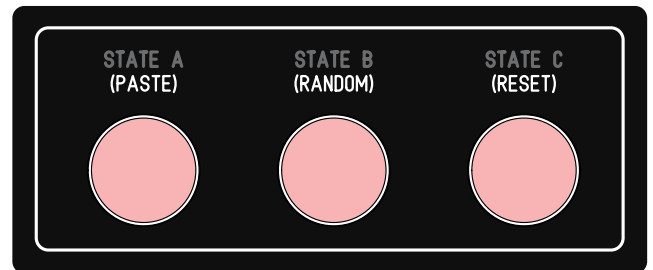

STATE B - RANDOM

Randomizes the current screen settings to all new random values, only on the currently selected channel.

If used in the Main Screen it will randomize only the settings available on the Main Screen.

STATE C - RESET

Resets the current screen settings to the loaded preset settings and only on the currently selected channel.

If used in the Main Screen it will reset all of the selected channel's settings.

STATES

Every channel has 3 States, every State is independent and can have completely different settings. Think of them as instantly accessible channel presets. They can be used to create drastic or slight changes to a CV output.

State changes are immediate, once engaged the new settings take control.

They can be assigned to a CV input, the incoming voltage level will trigger the corresponding state:

- STATE A < 1.6v
- STATE B > 1.6v & < 3.3v
- STATE C > 3.3v

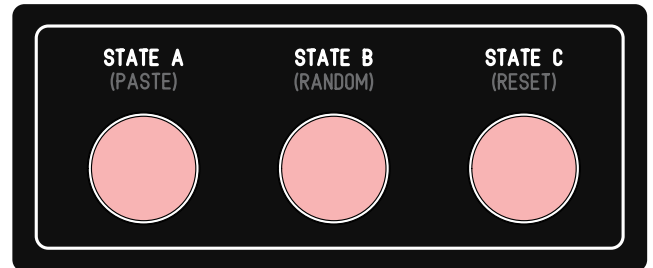

STATES PROBABILITY

States can also be configured to automatically change, at every clock cycle, according to probability settings.

To enter this screen users can double click on any State button.

Configuring the amount of probability for each state allows to fine tune the preponderancy of each channel. Encoder 1 configures the threshold point between State A and State B while Encoder 2 configures the point between State B and State C.

Once engaged the States will be changing automatically, if the user presses a State button it will momentarily change to the selected state until the next clock cycle triggers the new state probability and eventually change the state once again.

States Probability activity is suspended everytime the user exits the main screen to enter any other screen, it's important to suspend the activity to be able to edit the parameter of the current state without jumping to another state while in the editing process.

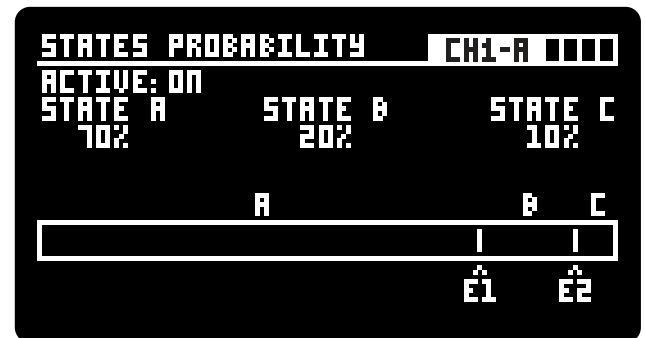

OPERATION MODES

There are 2 main operation modes, independently selected for each channel. Choosing the Mode can be done in the [VOLTAGE] screen.

1. RANDOM VOLTAGE GENERATION

Fully featured random voltage generation in the time and voltage domain with fully controlled range, probability, random distribution, smooth, quantization and a 32 step sequencer.



2. RANDOM ENVELOPE GENERATION

Fully featured random envelope generation in the time and voltage domain with fully controlled range, probability, random distribution, curve control.

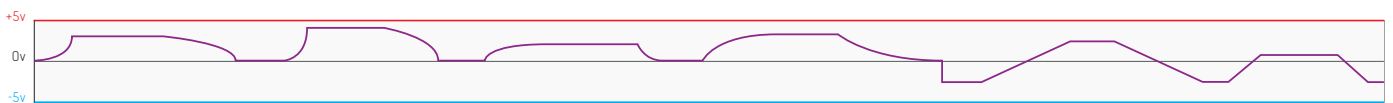

MAIN SECTIONS

No matter the mode selected there are two main sections which define how each channel operate: Voltage & Time

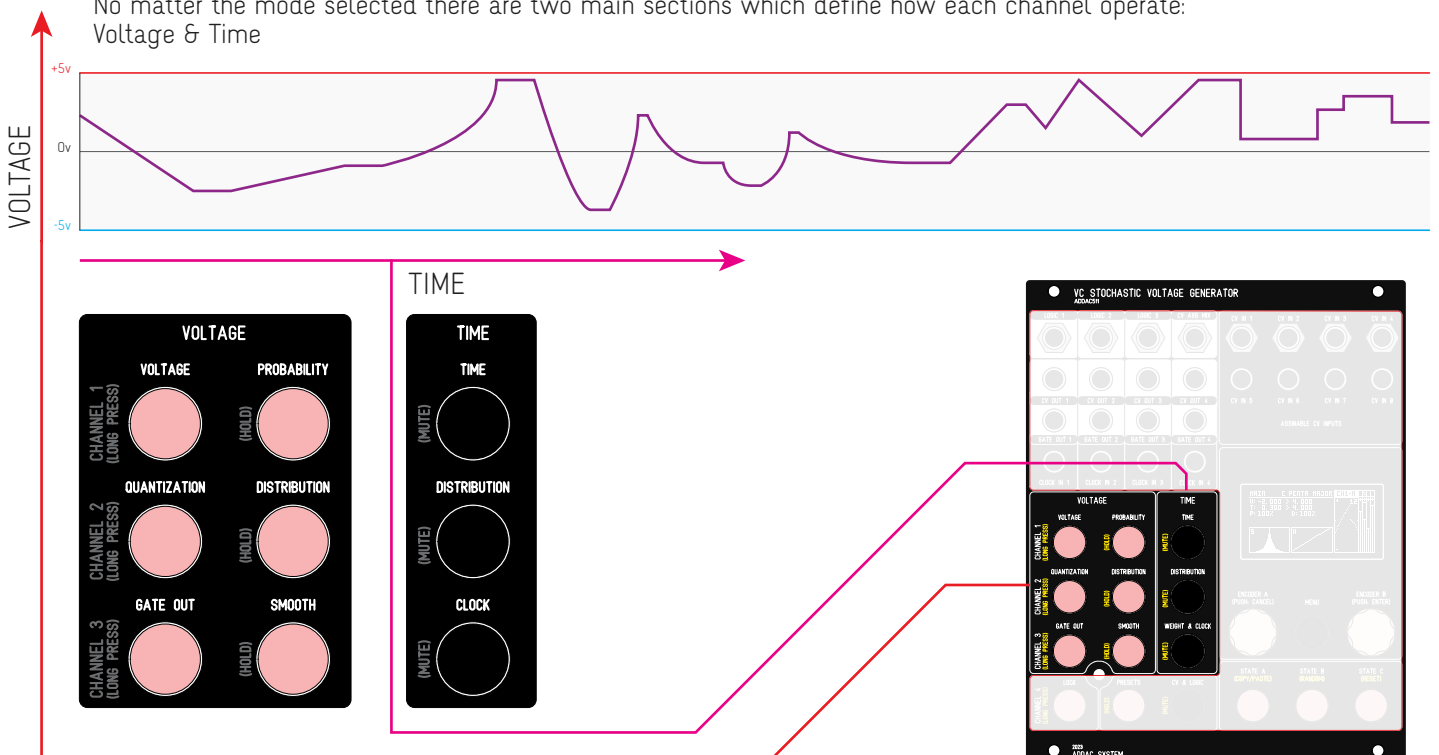

1. RANDOM VOLTAGE GENERATION

ADDAC511 User's Guide

VOLTAGE SETTINGS : SIGNAL FLOW

VOLTAGE GENERATION

The voltage generation process is made of a number of functions in a chain. Each function features it's own fast recall push button and configuration screen. At every clock tick a new voltage will be generated by this chain.

The [SMOOTH] and [QUANTIZE] order (A to B, B to A) can be altered in the [SMOOTH] window.

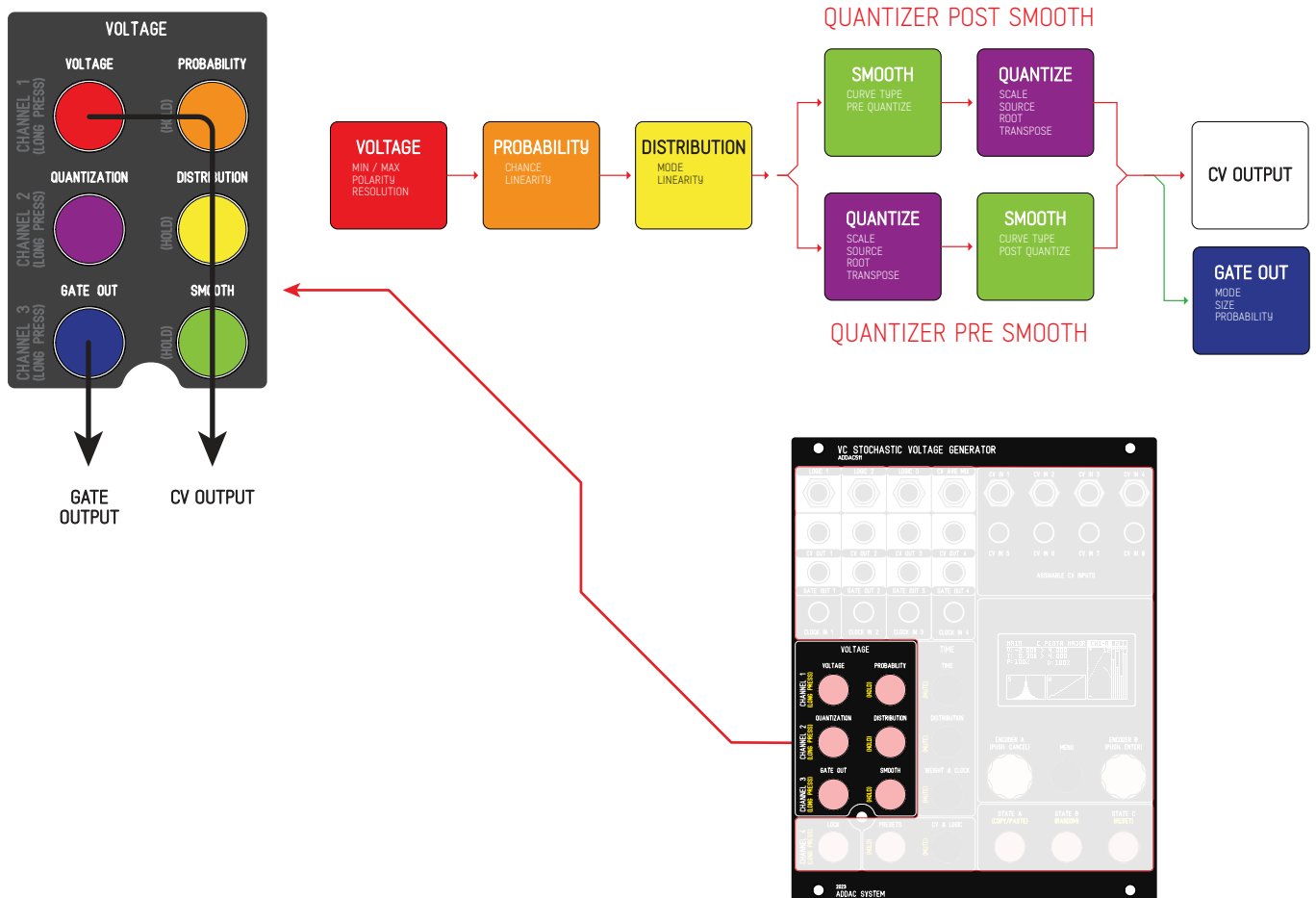

Here's an example plot of a Voltage generated output



1. RANDOM VOLTAGE GENERATION

ADDAC511 User's Guide

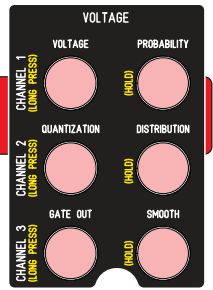

RANDOM VOLTAGE SETTINGS

VOLTAGE SCREEN:

Voltage range settings

- MODE** — The channels' operating Mode
- VOLTAGE MAXIMUM** — Sets the maximum voltage of the randomization range
- VOLTAGE MINIMUM** — Sets the minimum voltage of the randomization range
- CV POLARITY** — Sets a Positive (0 > +5V) or Bipolar range (-5V > +5V)
- STEPS** — Sets the number of steps to divide the MIN/MAX range defined from 2 to 320 or MAX (full 16bit resolution)
- RANGE LOCK** —

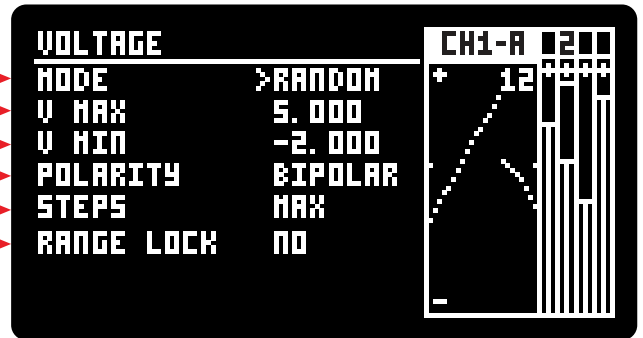

OFF: [V. MAX] & [V. MIN] defines the range minimum and maximum boundaries independently
 ON: Locks the current range defined, editing [V. MAX] will also change [V. MIN] and vice-versa.

QUANTIZATION SCREENS:

There are 2 Quantization screens, pressing the [QUANTIZATION] button will change between the 2 screens.

- SCALE** — Select from a few standard scales plus a custom setting where the user can freely choose the scale notes.
- SOURCE** — The source to be quantized, by default is set to the current channel although it can be set to any of the other channels or cv inputs working as a quantizer
- ROOT NOTE** — The scale Root note
- TRANSP MODE** — SEMITONES: Transposition in semitones intervals
 SCALE DEGREE: The scale degree transposition, transposes within the scale notes, in case of standard 7 note scales it can be used for modes:1-Ionian, 2-Dorian and so on.
 OCTAVES: Transposition in octave intervals
 CENTS: Transposition in cents intervals
- TRANSPOSE** — The transposition value

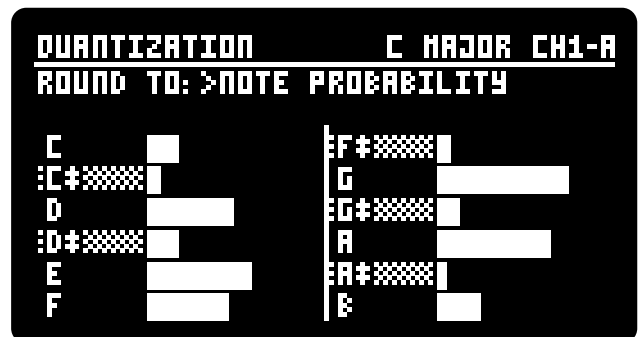
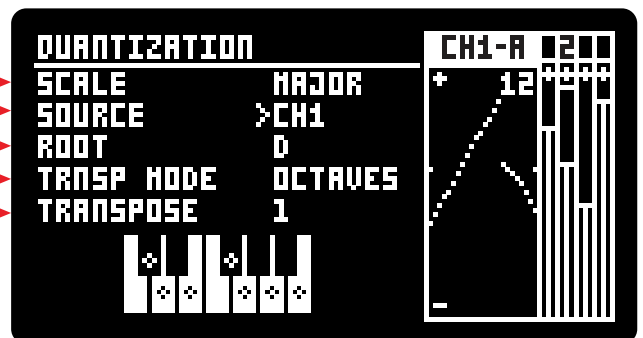

SCALE DEGREES TRANSPOSITION	
Ex: C Major scale - 7 notes scales behaves as standard scale modes	
1 = IONIAN	C D E F G A B
2 = DORIAN	D E F G A B C
3 = PHRYGIAN	E F G A B C D
4 = LYDIAN	F G A B C D E
...	
-1 = LOCRIAN	B C D E F G A
-2 = AEOLIAN	A B C D E F G
-3 = MIXOLYDIAN	G A B C D E F

More info regarding the quantizer operation on page 39.

1. RANDOM VOLTAGE GENERATION

ADDAC511 User's Guide

RANDOM VOLTAGE SETTINGS

GATE OUT SCREEN: (same as in other modes)

Settings control the Gate Out behaviour

SIZE

Percentage of gate ON time in relation to the step size

PROBABILITY

Output probability from 0% (no output) to 100% (always outputs). Also available is 1ms and 10ms for triggers.

SKIP STEPS

This feature introduces some disruption on the Gate Out behaviour, keeping its output low at every X steps.

OUTPUT ORDER

The order at which the CV and Gate is sent to the physical outputs. Although the time difference between the two outputs will still be microseconds apart this order may be important depending on what is being patched to.

CV/GATE: CV before the Gate Output

GATE/CV: Gate before the CV output

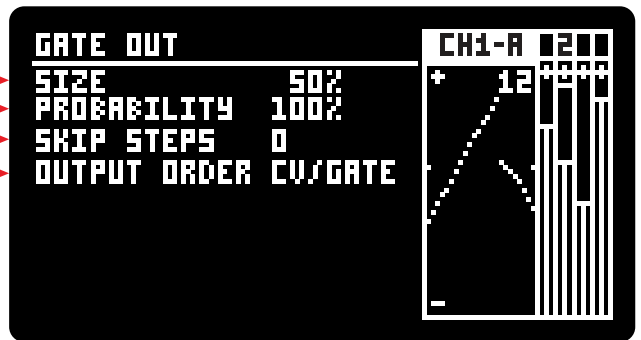

PROBABILITY SCREEN (same as in other modes)

Output probability settings, determines if it will generate a new CV at the current step or skip it and hold the current value until the next step.

PROBABILITY

Sets the probability of new generated voltages to be interrupted and not sent to the output

0% = All new voltages will be canceled

100% = No new voltages will be canceled

SKIP STEPS

This feature introduces some disruption on the CV output behaviour, skipping the CV generation at every X steps.

APPLY TO

CV: only applies the probability to the CV output, Gate Out will still be generated.

CV+GATE: applies the probability to both the CV and Gate output

LINEARITY

Sets the probability distribution curve

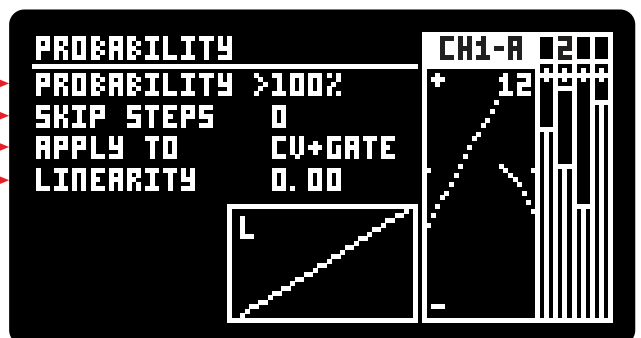

1. RANDOM VOLTAGE GENERATION

ADDAC511 User's Guide

RANDOM VOLTAGE SETTINGS

VOLTAGE DISTRIBUTION SCREEN

Allows for non-linear distribution of the voltage randomized as described in Page 10.

MODE
OFF, FREE & WALK

POSITION
Positions the distribution peak.

SPREAD
Sets the Q factor for the distribution curve.

LINEARITY
Sets the overall distribution curve.

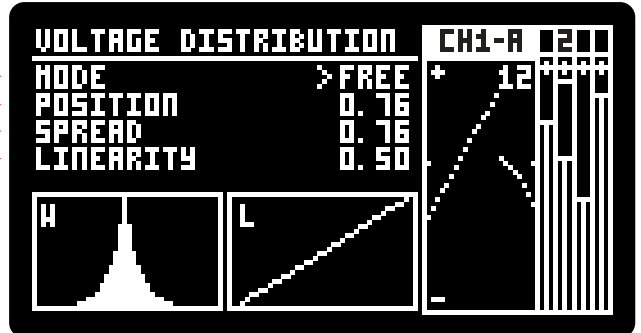

SMOOTH SCREEN

Settings control the interpolation between each two random points

CURVE TYPE
The type of curve used for the interpolation
LIN: Linear interpolation
LOG: Logarithmic interpolation
EXP: Exponential interpolation
BEZIER: Bezier curve interpolation

DURATION
The duration of the interpolation as a percentage of the step size

QUANTIZE
Quantizer Pre/Post setting:
Pre: Quantizer into Smooth for glissando type effect
Post: Smooth into Quantizer for arpeggio type effect

TRIGGER GATE
YES / NO: When Yes is chosen this feature triggers the Gate output at every interpolation step change

RESOLUTION
A bitcrusher applied on the incoming value, limiting the DAC resolution from 16 bit to 2 bit, at 2 bit the DAC range is limited to 4 values, 8 at 3 bit, 16 at 4 bit, 32 at 5 bit and so on up to 16 bit where the resolution is 65536

STEP MODE
This feature transforms the linear interpolation in user defined interval steps:
OFF: No stepping, smooth interpolation
VOLTAGE STEPS: interpolates at defined voltage steps
TIME: interpolates at defined time steps

STEPS / STEP TIME
STEPS: Sets the number of steps to divide the interpolation distance
STEP TIME: Sets the time interval between interpolation changes

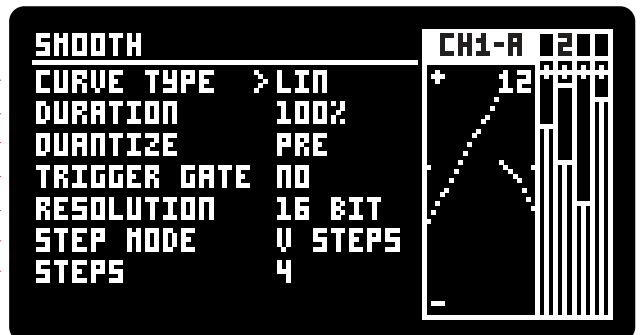

USING SMOOTH WITH CLOCK INPUTS MAY RESULT IN BAD TIMINGS AS THE MCU IS CONSIDERING THE LAST INTERVAL BETWEEN 2 GATES, IF THE EXTERNAL CLOCK ISN'T STEADY THE INTERPOLATION DURATION WILL NOT MATCH

1. RANDOM VOLTAGE GENERATION

ADDAC511 User's Guide

VOLTAGE & GATE OUT EXAMPLES

Here's a few graphical examples of the Voltage and Gate Out settings.

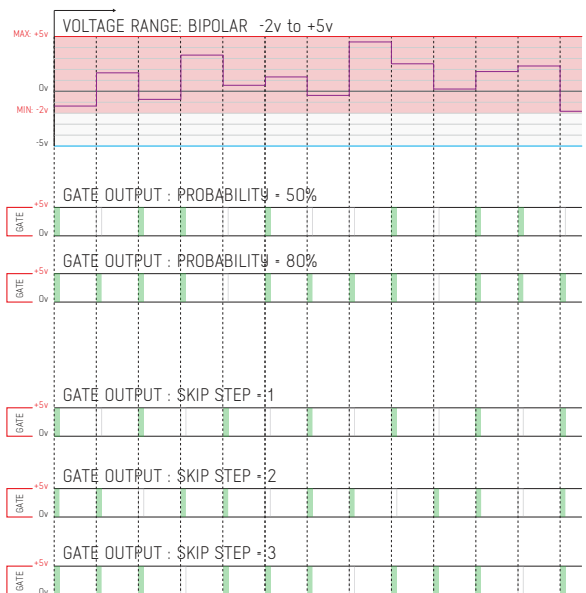
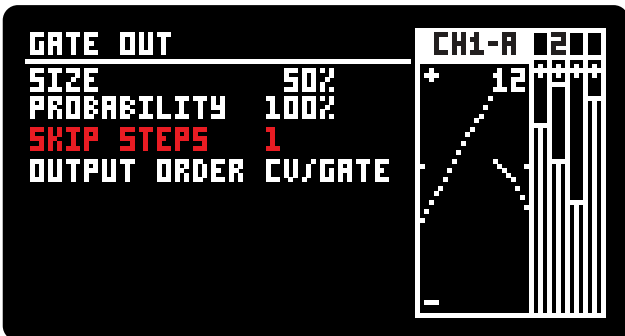
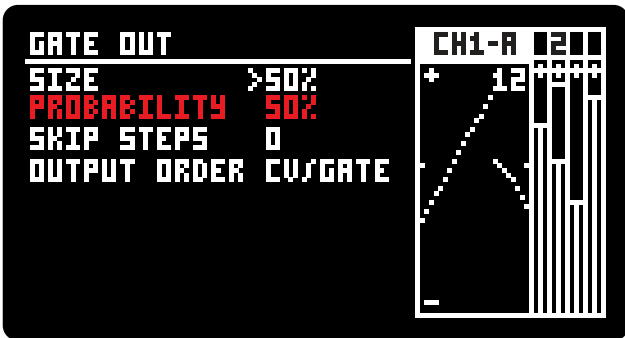
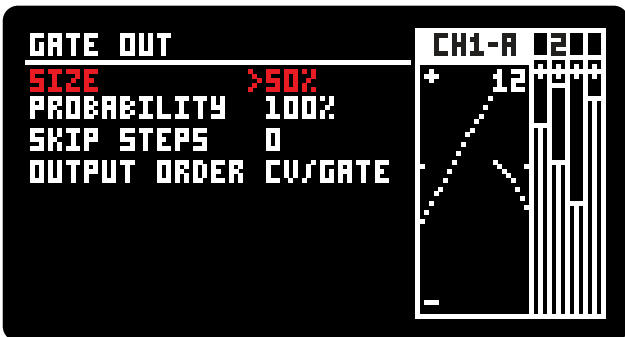
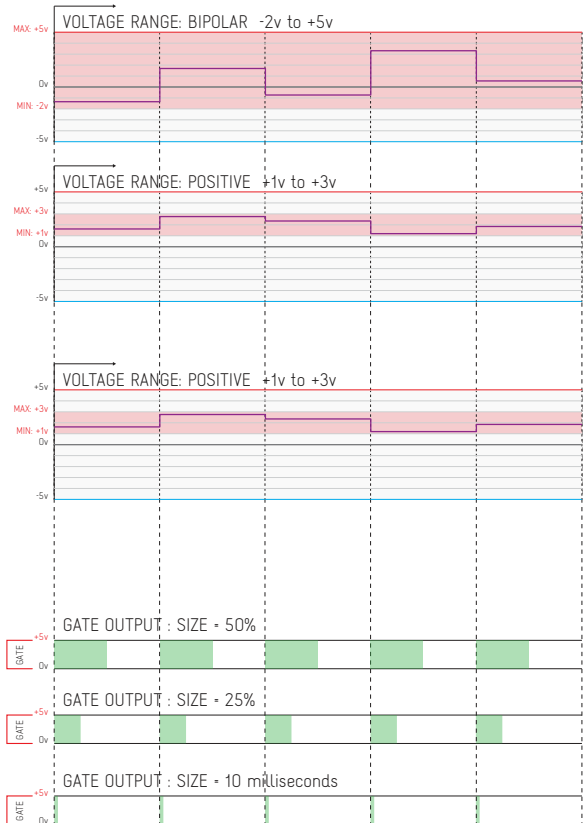
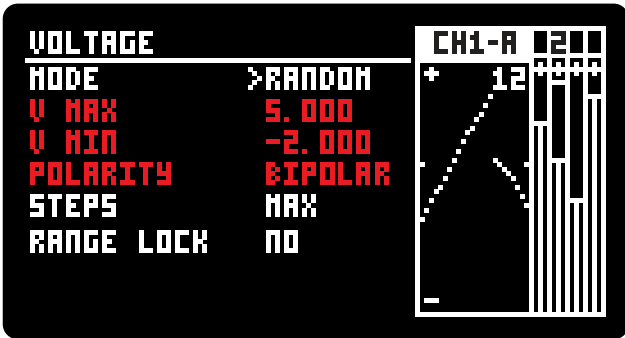

1. RANDOM VOLTAGE GENERATION

ADDAC511 User's Guide

VOLTAGE PROBABILITY

Here's a few graphical examples of the Voltage and Gate Out [PROBABILITY] settings. Notice how they can be dependent or independent.

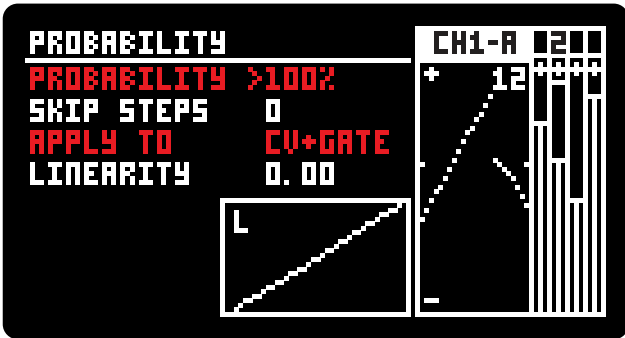

APPLY TO

When [APPLY TO] is set to CV+GATE the Gate only outputs when the probability is true. Applying the probability only to CV leaves the Gate intact, outputting every clock tick. This makes the Voltage Probability independent from the Gate Probability.

GATE PROBABILITY

The Probability function in the Probability Screen is the master probability. The one inside the Gate Out Screen

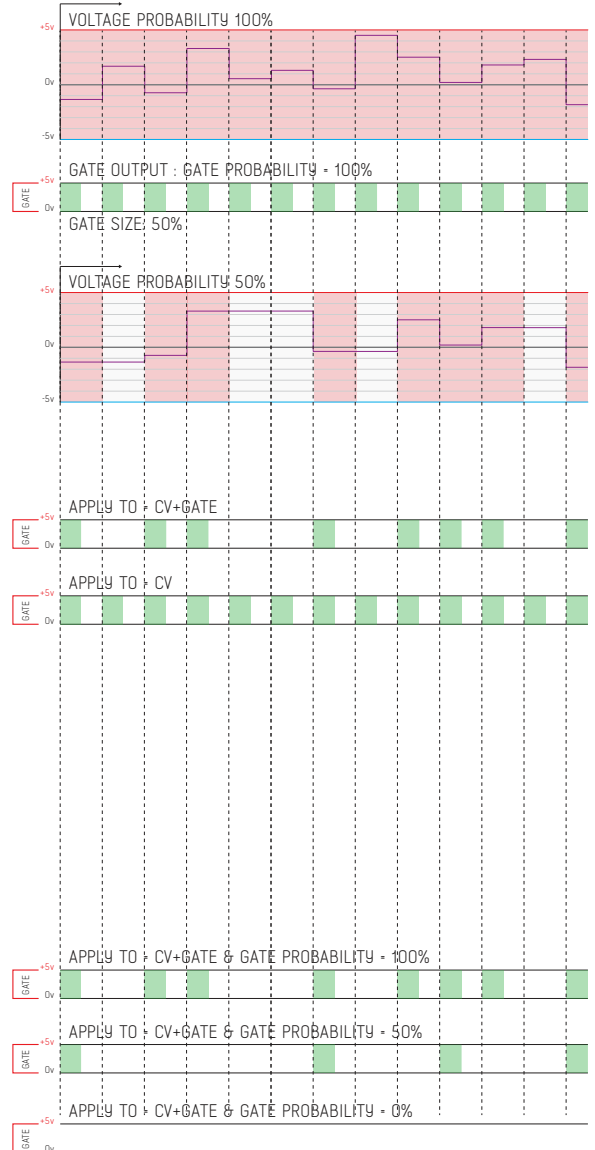
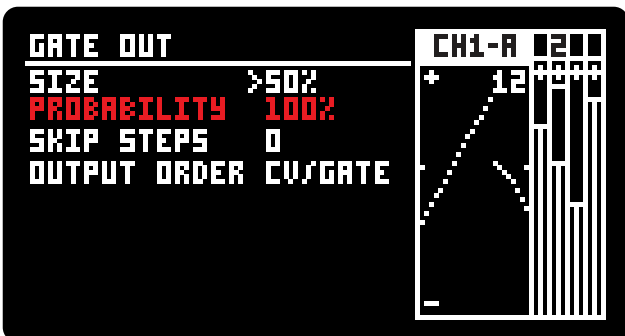

1. RANDOM VOLTAGE GENERATION

ADDAC511 User's Guide

VOLTAGE AND TIME DISTRIBUTION

These screens set the probability distribution for each random generation made in the time and voltage domain.

Every new random value by default is generated using a principle of uniform distribution (equal probability for all possibilities) however these can be weighted, meaning that they can be defined to make a certain range area more predominant, while always keeping the result within the voltage range defined in the [VOLTAGE] screen.

The weighted generation may follow three types of probabilistic distributions: uniform distribution, a slightly modified normal distribution and walk/drunk distribution (walk mode).

Uniform distribution (OFF), as mentioned above, has no weight, any value within the defined range has equal probability of being selected.

Normal distribution (FREE) is bell shaped, it can be described by its mean value and a deviation around that value defined by [POSITION]. Most random values will be around this position with more or less deviation depending on the [SPREAD] value. In our modified version of the normal distribution, if the calculated value is outside the selected voltage range, it is brought back inside the range.

Walk (WALK), like uniform distribution has equal probability for all possible values but restrains its range within a proximity to the previous value, resulting in a plot similar to the stock market as an example.

The probabilistic distribution is further influenced by the linearity parameter, which tilts the probability distribution either towards the lower or higher ranges.

MODES

The CV out value will have different probability characteristics, depending on the mode setting:

1. OFF

Uniform distribution (equal probability for all CV values)

2. FREE

Normal distribution, folding back at the upper and lower limits, parameters:

POSITION - Central value of probability distribution (mean)

SPREAD - Allowed deviation relative to the position (deviation)

3. WALK

The next value has a maximum deviation from the last value, parameters:

SPREAD - Allowed deviation relative to the last CV out value

LINEARITY

This parameter is independent of the mode selected, it further weights the probability distribution to give preference to lower or higher values, as if tilting the distribution.

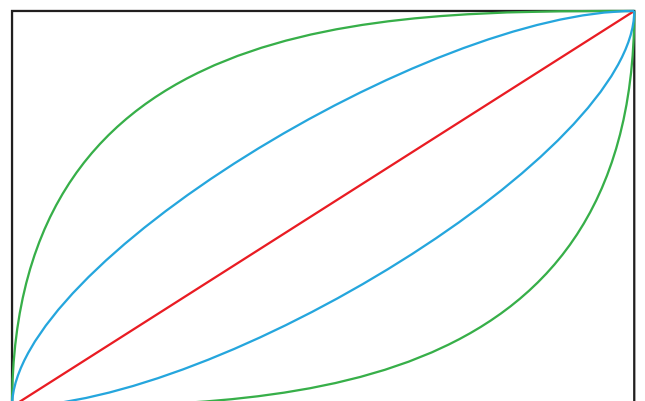
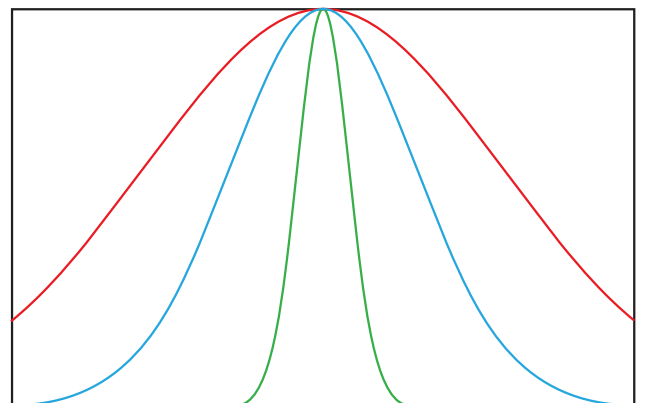
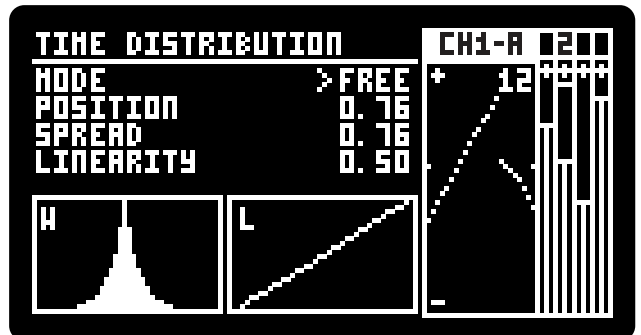
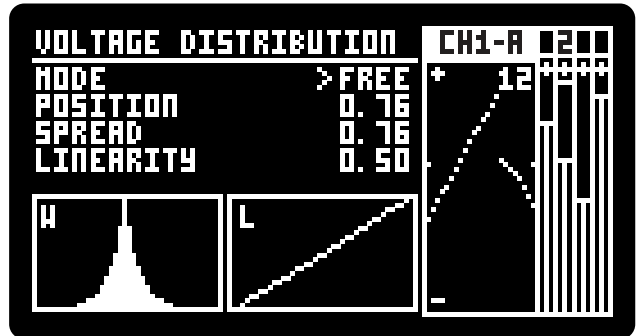

1. RANDOM VOLTAGE GENERATION

ADDAC511 User's Guide

SMOOTH INTERPOLATION

Smooth allows to interpolate between the generated values at every clock tick. The user can set the duration of the interpolation between 0 and 100%, this duration is in sync with the clock keeping correct timing even with a random clock.

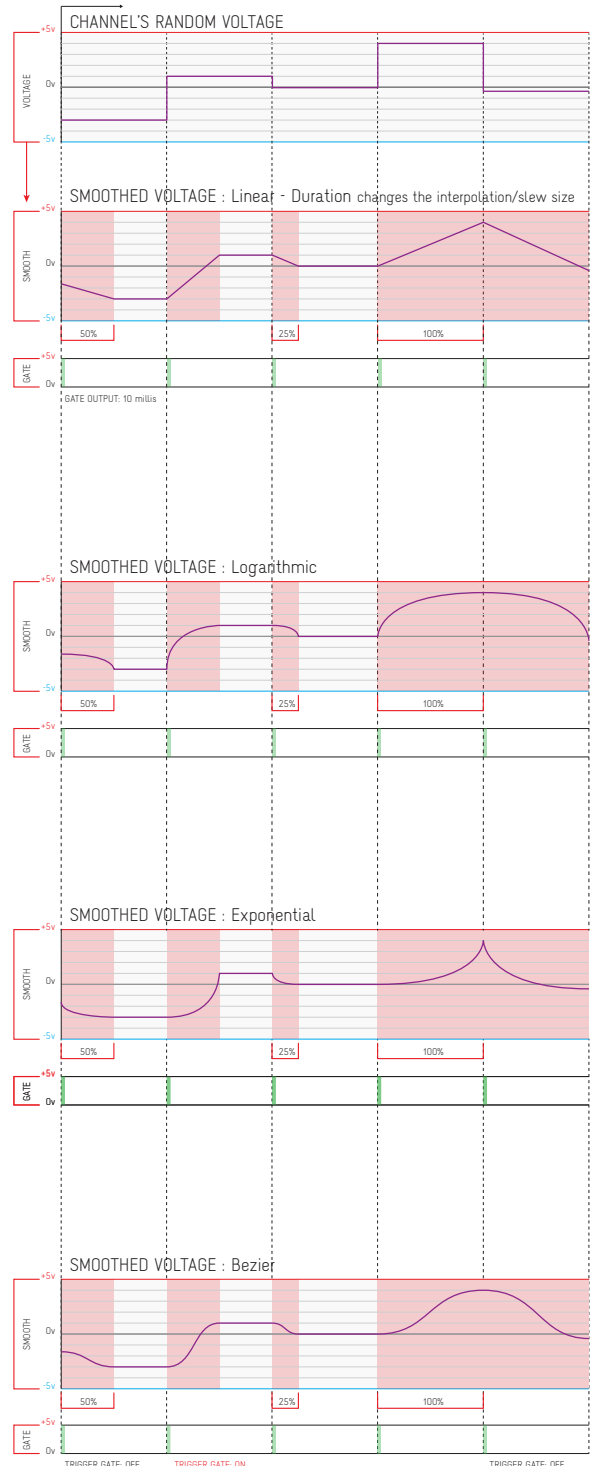
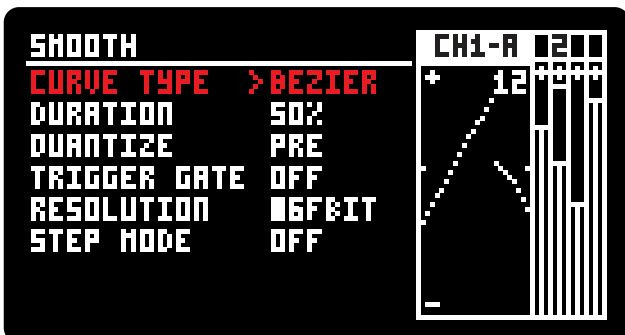
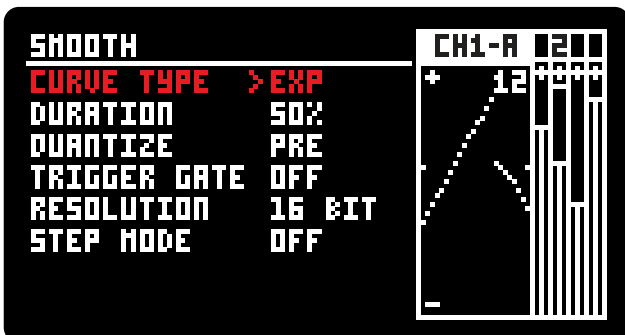
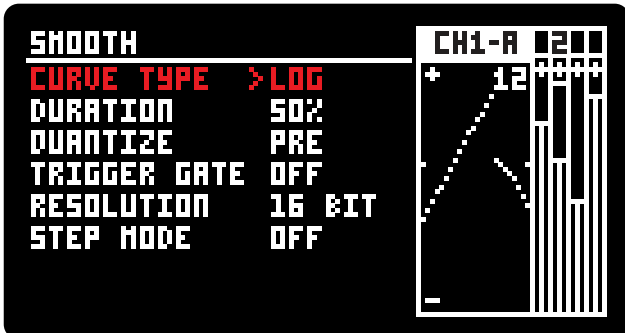
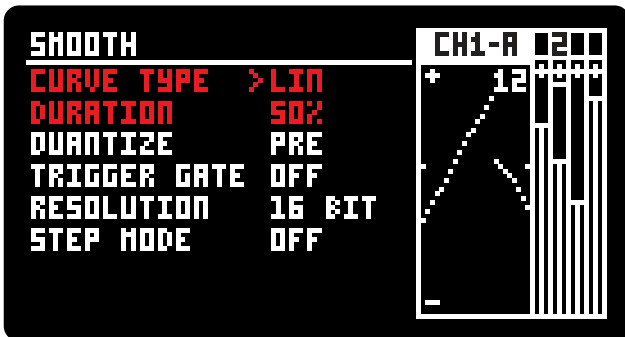

1. RANDOM VOLTAGE GENERATION

ADDAC511 User's Guide

STEPPED INTERPOLATION

Besides smoothing in between each voltage step, smooth can be used to create stepped interpolations using [RESOLUTION] and [STEP MODE]. [TRIGGER GATE] is used to trigger at every interpolation step.

Here we're showing graphical examples of these in action.

Quantization is set to PRE if set to POST all these examples would be quantized to the scale defined in the Quantization screen.

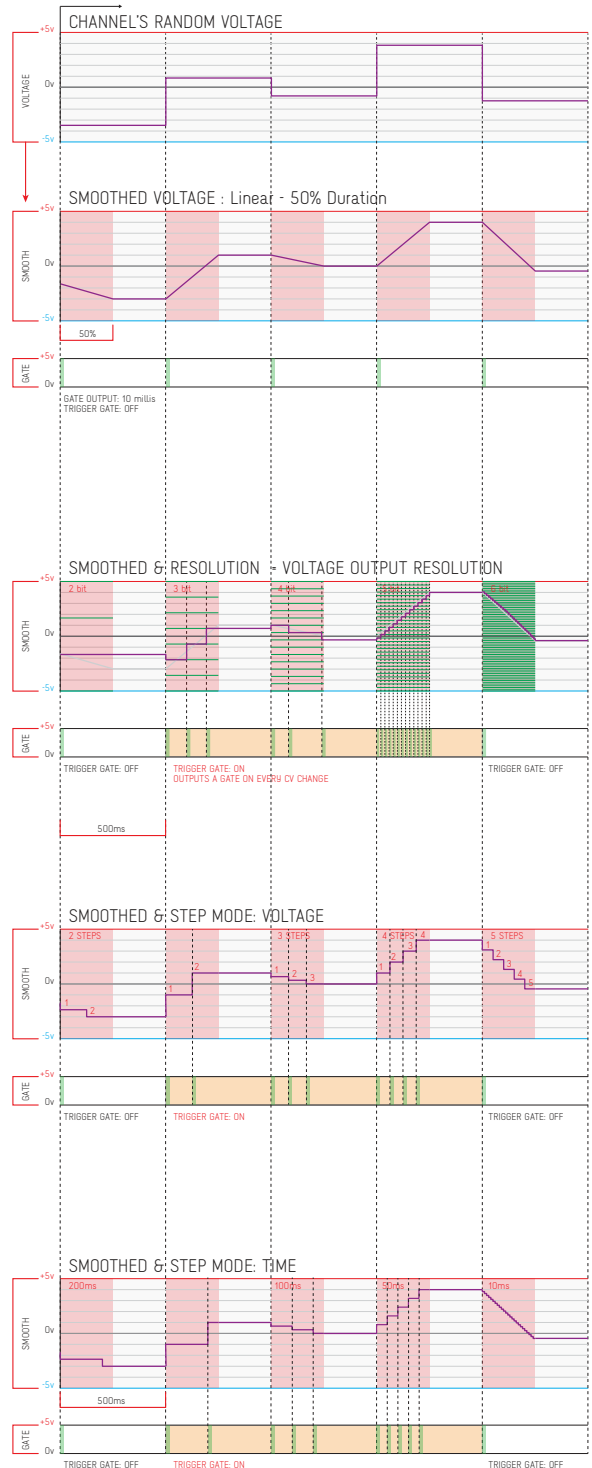
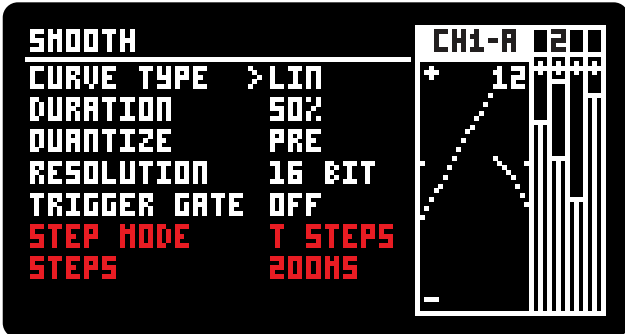
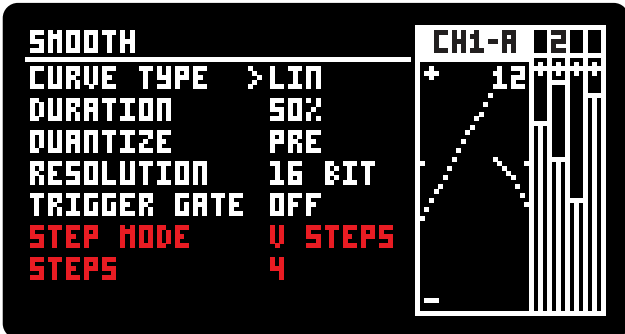
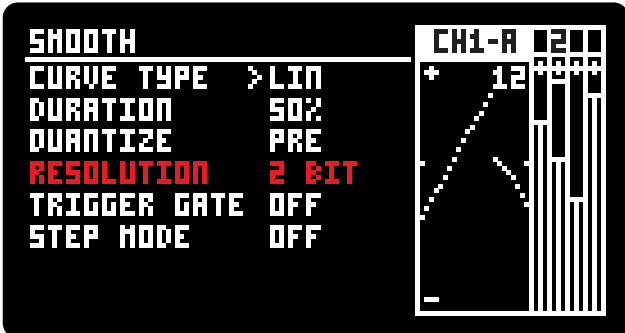
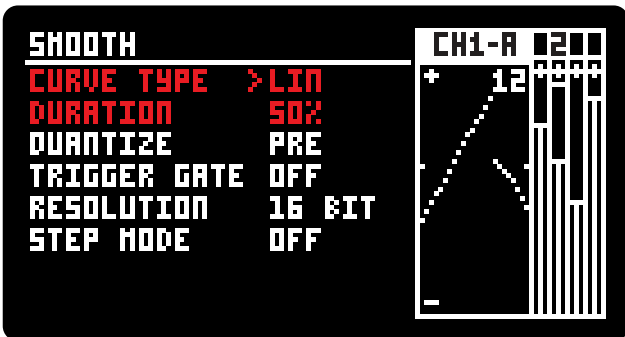

1. RANDOM VOLTAGE GENERATION

ADDAC511 User's Guide

TIME SETTINGS : SIGNAL FLOW

TIMING GENERATION

Time settings determines the rate at which the voltage and gate are generated, the interval between every generation step is defined by the setting in the [TIME] screen, That value is then "balanced" by the [DISTRIBUTION] screen settings and a virtual clock tick is generated.

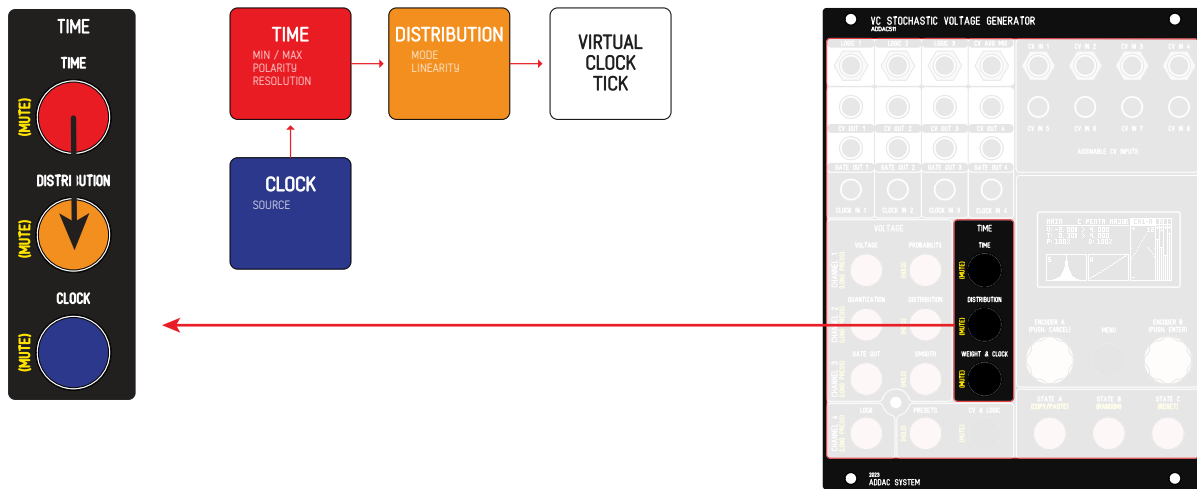

CLOCK SOURCES

There are 3 main sources to trigger each channel timing.

1. 4 virtual clocks, one per channel. Each channel can select itself (INTERNAL) or any other channel.
2. The 3 Logic Outputs, whenever the logic output goes high it triggers the channel's clock.
3. The 4 Clock inputs, any input can be routed to any channel.

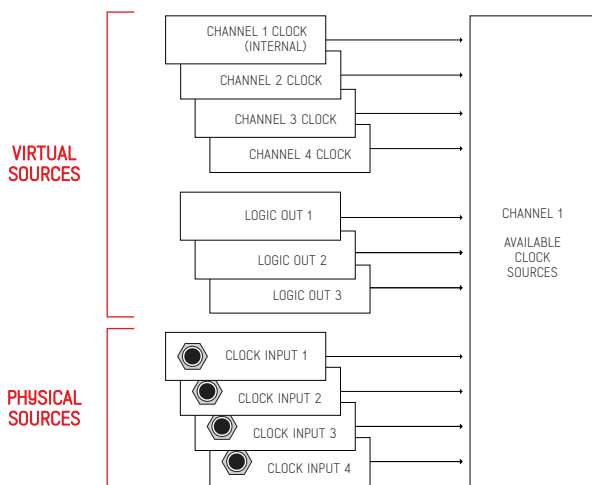

1. RANDOM VOLTAGE GENERATION

ADDAC511 User's Guide

TIME SETTINGS : TIME MODE (milliseconds)

In Time Mode the clock is defined in milliseconds, the step length will be randomized from the interval defined by the Time Min & Time Max parameters.
Setting the Time Minimum higher than Time Maximum will result in a steady clock at a fixed rate without any randomization.

TIME SCREEN:

TIME MODE

Time mode uses seconds as a reference, at every cycle it randomizes a new value in the range defined by the Time Min / Max settings.

TIME MAXIMUM

Sets the maximum step time in milliseconds.

TIME MINIMUM

Sets the minimum step time in milliseconds.

RANGE MODE

Relative: Allow independent changes to Max and Min values

Absolute: Keeps the range defined, changing Max or Min will also affect the other parameter, one pushes the other to keep the same range.

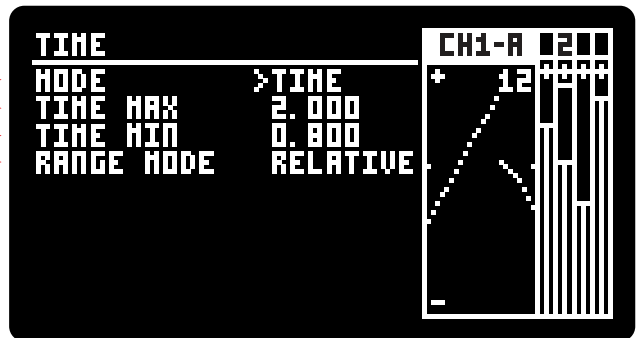

TIME DISTRIBUTION SCREEN

Allows for non-linear distribution of the time randomized

MODE

FREE
WALK

POSITION

Positions the distribution peak.

Q FACTOR

Sets the Q factor for the distribution curve.

LINEARITY

Sets the overall distribution curve.

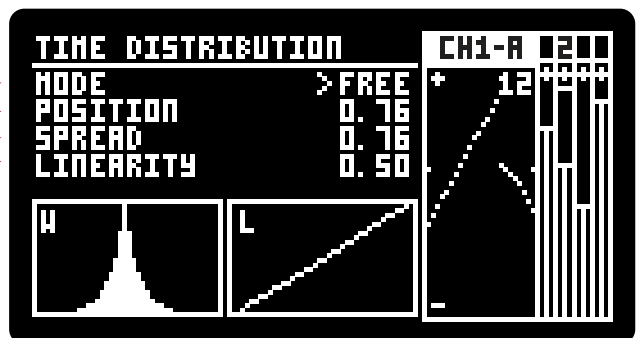

1. RANDOM VOLTAGE GENERATION

ADDAC511 User's Guide

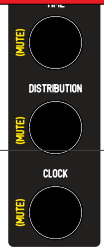

TIME SETTINGS : BPM MODE

In BPM Mode the clock works as a standard BPM clock, the step length will be randomized from the intervals defined in the Distribution screen.

TIME SCREEN:

BPM MODE

In BPM mode the clock uses a constant timing value. It can also be set to follow another channel BPM choosing BPM CH2, BPM CH3, BPM CH4. In this case the BPM field is not selectable and will show the value of the chosen follow channel.

BPM

Sets the clock's Beats Per Minute.

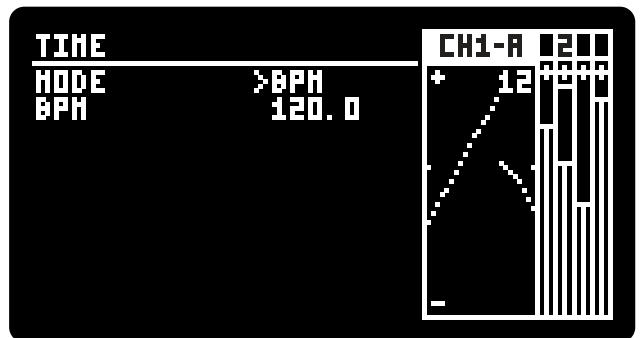

BPM DISTRIBUTION SCREEN

In BPM Mode the user can set up to a total of 11 divisions, any division from 32/1 to 1/32 is possible, all odd combinations included.

A second parameter visualised as a white bar sets the probability / predominancy of each division active.

Only ratios with probability above zero will be active.

Repeated ratios can be used.

The Menu button is used for clearing the edited value to the default 1/1 with 0% probability.

Both encoders push button will exit the screen.

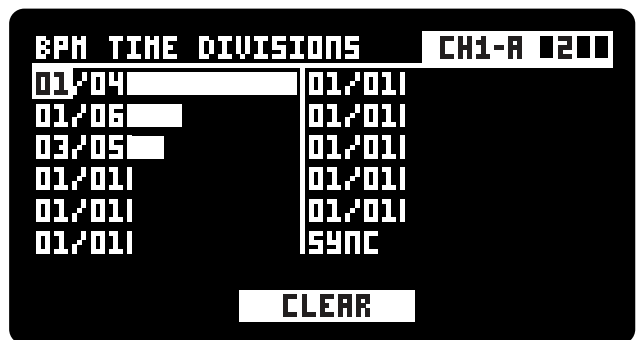

The SYNC slot output division is variable, it outputs the required time until the next beat. This will make sure the next step falls back on the beat. This is especially useful when using odd time divisions as it resets any offset, you can see a graphical example below.

SHOWING GATE OUT AT 50% STEP SIZE
CLOCK BEAT

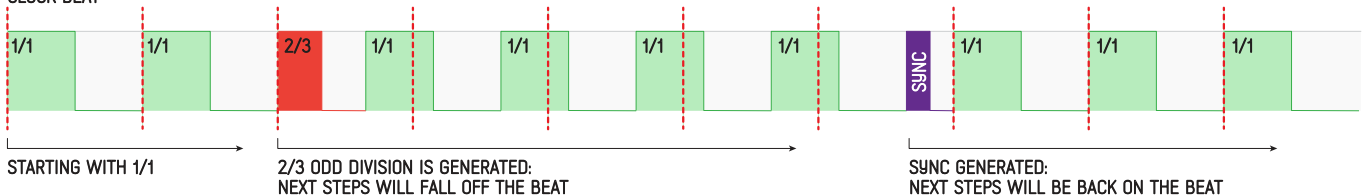

1. RANDOM VOLTAGE GENERATION

ADDAC511 User's Guide

CLOCK

CLOCK SCREEN:

Configuring the selected channel's clock origin.

CLOCK SOURCE

Sets the origin of the Clock, options are:

INTERNAL (default): uses its own channel clock.

CHANNEL X: chooses one of the other channels clocks.

CLOCK IN X: chooses one of the 4 clock physical jack inputs

LOGIC X: chooses one of the 3 Logic outputs

INTERNAL

keeps the channel independent from other channels.

All other options makes the channel dependent to the source chosen. In these cases the clock parameters available will change according to the clock source selected.

CHANNEL 1 to 4

Syncs to any other channel: slave mode.

CLOCK IN 1 to 4

Uses the frontpanel clock inputs to sync to external sources.

LOGIC 1 to 3

Uses the internal logic outputs as a clock.

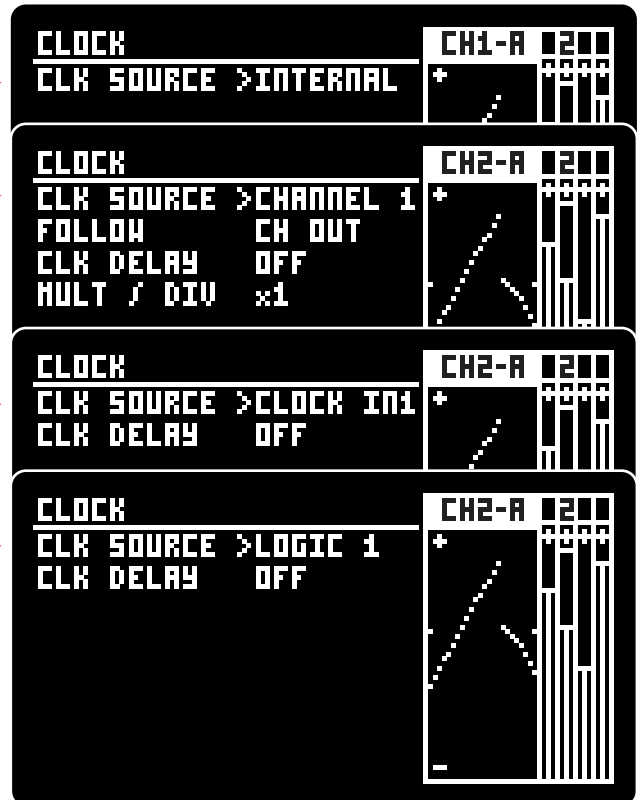

CHANNEL 1 SELECTED

CLK SOURCE	CHANNEL X TIME MODE	CHANNEL 1 TIME MODE	AVAILABLE PARAMETERS	EXTRA PARAMETERS
INTERNAL				
CHANNEL X	TIME	TIME	USE TIME	
		BPM	USE TIME	
	BPM	TIME		WHEN OFF: MULT/DIV
		BPM	FOLLOW	CH BPM / CH OUT
		USE TIME	WHEN OFF: MULT/DIV	
CLOCK IN X			USE TIME	
LOGIC X			USE TIME	

The grey area shows parameters that are defined outside the clock configuration screen, these parameters are defined in the time screen.

1. RANDOM VOLTAGE GENERATION

CLOCK MASTER/SLAVE

Sync Channels

Channels can be sync'ed to other channels using the [CLOCK SOURCE] setting in the [CLOCK] screen. By default every channel is a Master channel, independent from all others.

To change any channel to Slave the user just needs to select to any other channel in the [CLOCK SOURCE] parameter, this will make that channel follow the selected clock.

When set to Slave the [TIME] and [DISTRIBUTION] screens will then be used to set the parameters for a new function: Clock Delays. When active [CLOCK DELAY] will use the slave channel's [TIME] and [DISTRIBUTION] parameters to generate a delay value that will be added to the clock tick, effectively delaying the incoming clock. This delay can be steady or random depending on the [TIME] and [DISTRIBUTION] settings selected.

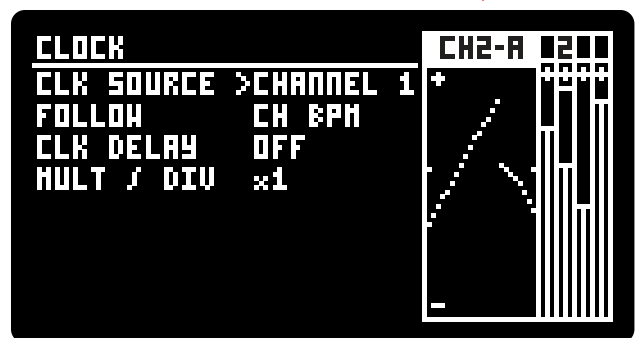
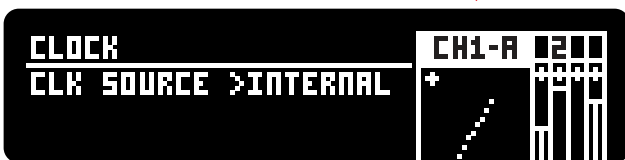
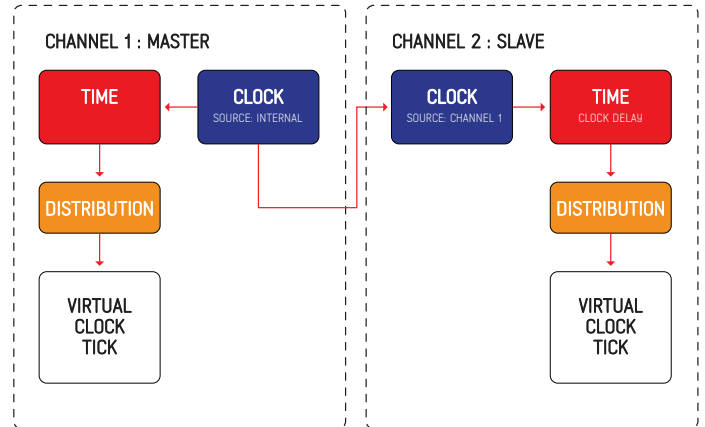

1. RANDOM VOLTAGE GENERATION

ADDAC511 User's Guide

CLOCK FOLLOW

Sync Channels: BPM Mode

The best practice to sync channels is to choose one to be the master channel setting its [CLK SOURCE] to [INTERNAL]. The remaining channels can then refer to this master channel.

In this example Channel 1 is set as [INTERNAL]
Channel 1 [TIME MODE] is set to BPM

The [TIME MODE] setting is very important here as it will show different options if set to [BPM] or [TIME].



Channel 2 [CLK SOURCE] is set to sync to Channel 1

FOLLOW

Follow will determine the sync mode.

The slave channel can sync to:

[CH BPM] the virtual grid of the master channel BPM

[CH OUT] the real-time gate output.

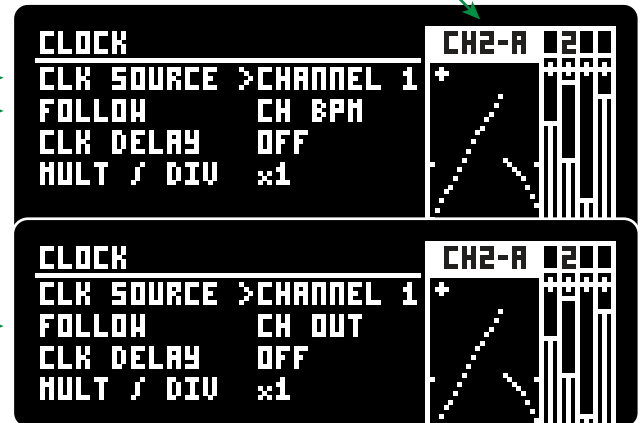

FOLLOW EXAMPLE

Here is a side by side comparison of both [FOLLOW] options including examples for diferent [MULT/DIV] values.

FOLLOW CHANNEL BPM

CHANNEL 1 Virtual BPM



This would be the Channel 1 virtual BPM.

Virtual here means this is not the Channel 1 real output but instead the BPM grid to which channel 1 is syncing to. Channel 2 will then follow this virtual grid depending of the [USE TIME] and [MULT/DIV] settings.

FOLLOW CHANNEL OUTPUT

CHANNEL 1 Real-time GATE OUTPUT

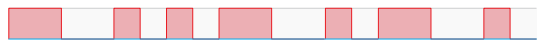

This would be the Channel 1 real-time Gate Output. This output will depend on all other parameters on Channel 1, for simplicity in the example above it's randomizing whole and half notes.

[MULT / DIV]

When [USE TIME] is Off, the virtual BPM can be:

- . Multiplied (x1, x2, x3, x4, x5, x6, x7, x8, x16, x32)
- . Divided (/2, /3, /4, /5, /6, /7, /8, /16, /32)

CHANNEL 1 Virtual BPM

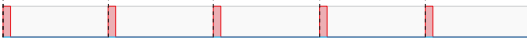

CHANNEL 2 - FOLLOW CH BPM

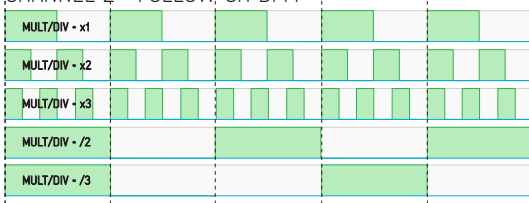

[MULT / DIV]

When [USE TIME] is Off, the virtual BPM can be:

- . Multiplied (x1, x2, x3, x4, x5, x6, x7, x8, x16, x32)
- . Divided (/2, /3, /4, /5, /6, /7, /8, /16, /32)

CHANNEL 1 Real-time GATE OUTPUT



CHANNEL 2 - FOLLOW CH OUT

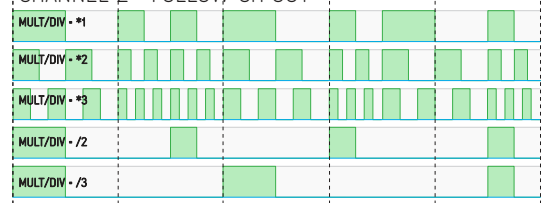

1. RANDOM VOLTAGE GENERATION

CLOCK DELAY: BPM

Sync Channels: Slave TIME MODE = BPM

[CLOCK DELAY]

The [CLOCK DELAY] parameter is used to cause deviation/delay to the incoming clock timing. In this case the Channel 2 [TIME MODE] setting is very important as it will behave differently if set to [BPM] or [TIME].

When using BPM the engine will use the time divisions set on the [TIME DISTRIBUTION] screen and generate a new interval from the divisions pool always using the Channel 1 BPM as reference ignoring the channel's own BPM setting.

[CLOCK DELAY] - ON & CHANNEL TIME MODE - BPM

In this example Channel 2 [TIME MODE] is set to [BPM]



FOLLOW

Follow will then determine the sync mode.

The slave channel can sync to:

[CH BPM] the virtual grid of the master channel BPM

[CH OUT] the real-time gate output.



When [USE TIME] is On there is no [MULT/DIV] option.

FOLLOW EXAMPLE

Here is a side by side comparison of both [FOLLOW] options, notice the time divisions selected

FOLLOW CHANNEL BPM

This will generate a consecutive stream of notes which lengths are randomized from the [TIME DIVISIONS] pool. As the current note reaches its final length a new note is immediately generated.

FOLLOW CHANNEL OUTPUT

This will create a delay to every incoming clock, the delay length is randomized from the [TIME DIVISIONS] pool. **Time divisions longer than the incoming clock are canceled by the next incoming clock and will not output.**

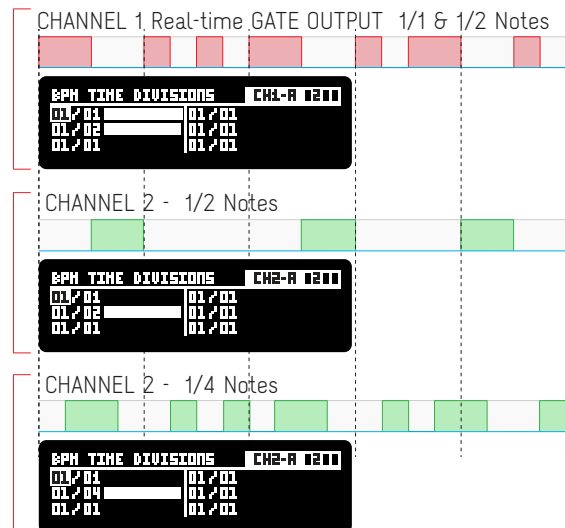
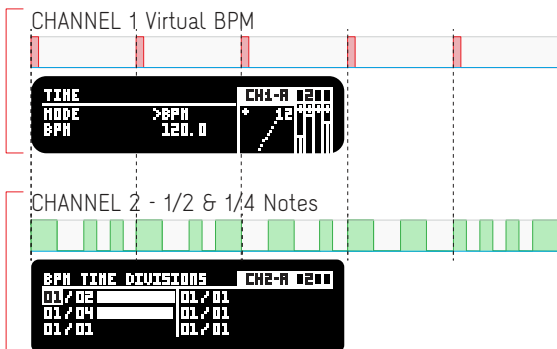

1. RANDOM VOLTAGE GENERATION

ADDAC511 User's Guide

CLOCK DELAY: TIME

Sync Channels: Slave TIME MODE = TIME

When using [TIME MODE] set to [TIME] the engine will simply add a delay to the incoming clock source. This setting is usefull used for generating time based delays, fixed or random, in this case although it is being triggered by the master channel BPM grid the delays are set in seconds and will most probably fall out of the grid creating odd delays.

The delay time is randomized from the range defined by the [TIME MIN] [TIME MAX] settings in the [TIME] screen.

Delay times longer than the incoming clock are canceled by the next incoming clock and will not output.

In this example Channel 2 [TIME MODE] is set to [TIME]
Keep in mind that Channel 1 [TIME MODE] is still set to [BPM].

FOLLOW

Follow will then determine the sync mode.

The slave channel can sync to:

[CH BPM] the virtual grid of the master channel BPM

[CH OUT] the real-time gate output.

When [CLOCK DELAY] is On there is no [MULT/DIV] option.

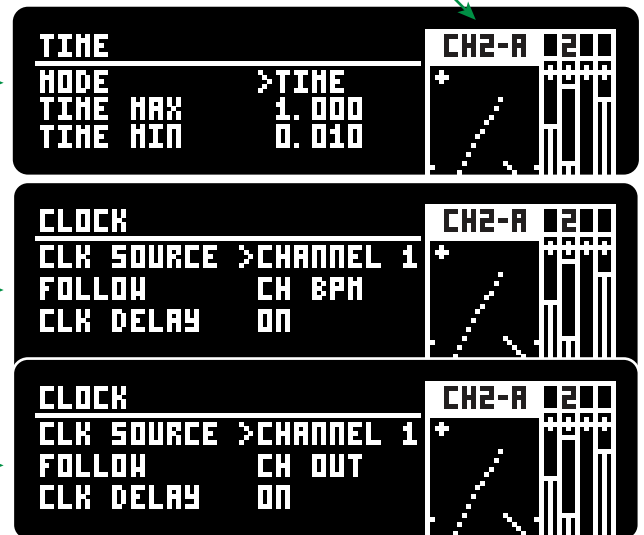

FOLLOW EXAMPLE

Here is a side by side comparison of both [FOLLOW] options, notice the time settings.

FOLLOW CHANNEL BPM

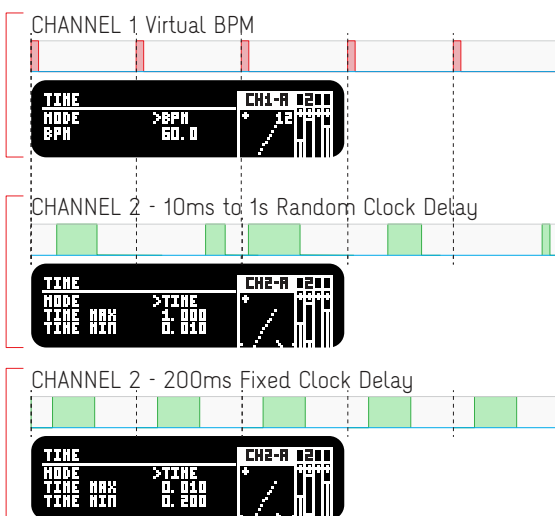

FOLLOW CHANNEL OUTPUT

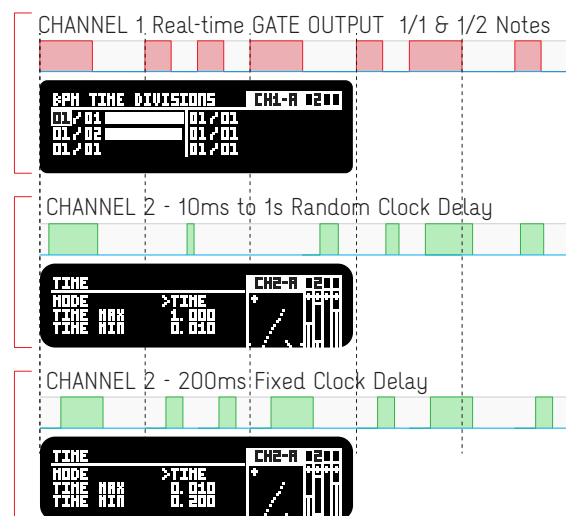

1. RANDOM VOLTAGE GENERATION

ADDAC511 User's Guide

CLOCK FOLLOW: More Examples

Sync Channels > Follow: CH BPM vs CH OUT

When setting an external clock the user can choose to follow the Master Channel BPM or Gate Output. Following the Master BPM will set a steady BPM for the Slave channel. Following the Gate Output of the Master channel creates complex changes on the Slave channel period. Below you can find graphical examples with all the different possible settings.

For easier visualization all gate representations show the Gate On time, Gate Length is always at 50%.
Master channel in RED : **Slave channel in GREEN**.

Follow: CH BPM



CHANNEL 1 MASTER : BPM

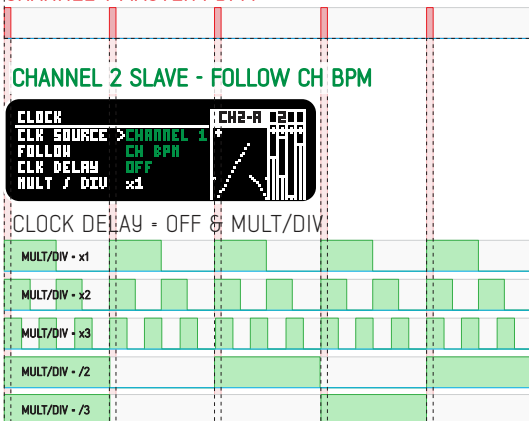

TIME MODE = BPM & CLOCK DELAY = ON
 Delay 1/2 & 1/4 Notes



TIME MODE = TIME & CLOCK DELAY = ON
 10ms to 1s Random Clock Delay

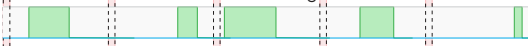

200ms Fixed Clock Delay (min > max: fixed speed)

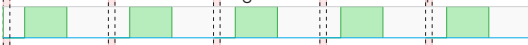

Follow: CH OUT



CHANNEL 1 MASTER : GATE OUTPUT

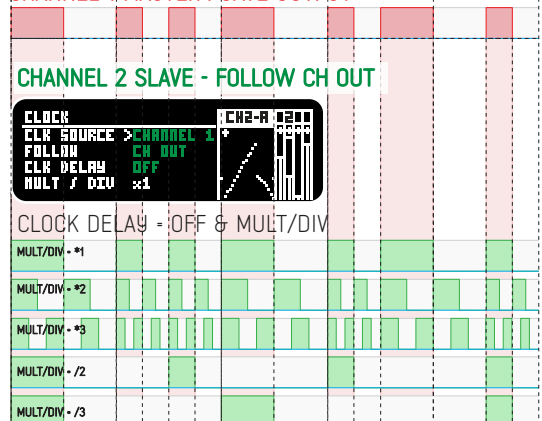

TIME MODE = BPM & CLOCK DELAY = ON
 Delay 1/2 Note

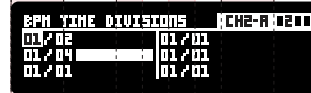
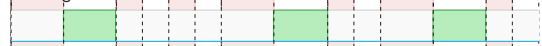

Delay 1/4 Note

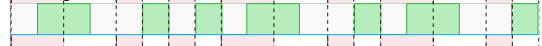

TIME MODE = TIME & CLOCK DELAY = ON
 10ms to 1s Random Clock Delay



200ms Fixed Clock Delay (min > max: fixed speed)

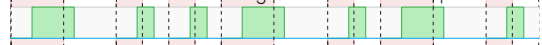

1. RANDOM VOLTAGE GENERATION

ADDAC511 User's Guide

LOCK : SEQUENCER

There are 2 Lock screens, pressing the [LOCK] button will alternate between these screens.

The Lock function is at heart a shift register, similar to the Turing Machine, once engaged instead of generating new random steps it locks to a sequence of up to 32 steps.

Users can also precisely edit the voltage and time values turning it into a full 32 step sequencer.

Whenever Sequence Lock [ACTIVE] is set to ON then the Voltage Mode if set to ENVELOPE will be forced to NORMAL

ENCODERS BEHAVIOUR

In these screens rotating [ENCODER A] scrolls through the parameters, [ENCODER B] edits their values.

SCREEN 1

ACTIVE

The state of the Lock function: TRACK/HOLD/ON

STEPS

The number of steps in the sequence

SEQUENCER MODE

Using the Mode parameter users can choose to:

- Use the sequence voltage values but keep the time between steps random.
- Keep random voltages happening but keep the timing locked to the sequence values
- Have both voltage and time coming from the sequence.

DIRECTION

FORWARD: Plays sequence forward
REVERSE: Plays sequence backwards
PING-PONG: Plays sequence in both directions

OFFSET

Offsets the sequence by X steps

TRANSPORT CONTROLS

Pressing [ENCODER B] triggers transport controls.

PLAY: Plays the sequence
PLAY ALL: Plays all channels
STOP: Stops the sequence
STOP ALL: Stops all channels
RESET: Resets sequence to first step
RESET ALL: Resets all channels



SCREEN 2

STEP EDITOR

Step Selection
Gate Output
Step Voltage
Step Time/Length
Step Probability
Current step playing

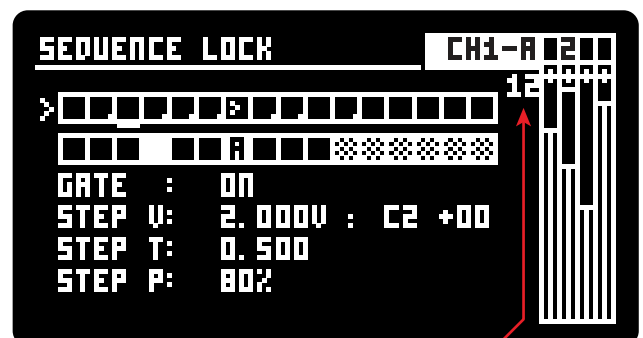

1. RANDOM VOLTAGE GENERATION

ADDAC511 User's Guide

LOCK : STATE

The channel's internal generation and lock feature are not active at the same time, although the internal generation can influence and write values into the lock sequence. For this there are 3 Lock States:

TRACK

When in Track mode the lock sequence is disabled and not editable. The internal generation is active and continuously stores its output into the lock sequence active steps in a loop.

As an example, if Steps are set to 8 then it will iterate over these 8 steps storing the new value over the oldest step.

HOLD

In Hold mode the sequence is locked, not playing but still editable.

The channel internal generation is active

As an example, if you have a sequence you don't want to erase but want to use the internal generation for a transition the Hold mode will keep your sequence safe.

ON

In ON mode the sequencer takes over, the internal generation is disabled unless special changes (Change Once / Change Allways) are programmed, the sequence can be played and edited in real-time.

	INTERNAL GENERATION	SEQUENCE LOCKED	SEQUENCE EDITABLE	SEQUENCE PLAYBACK
TRACK	YES	X	X	X
HOLD	YES	YES	YES	X
ON	X	YES	YES	YES

LOCK : STEP SETTINGS

GATE:

The Gate can be set to either On or OFF

Step Voltage:

The step voltage can be set in Volts (ex. 2v) or Notes (ex. C2) + Cents, the Cents parameter allows for step microtuning.

Step Time:

Unlike a conventional sequencer each step can have different lengths, this can be set in milliseconds or as a time division depending if the [TIME] is set to time or BPM.

This allows programming complex phrases where any time division can be set, ex. 1/16, 1/9 and 15/1 and where each step can have its own BPM.

Step Probability:

Sets the probability for the step to be outputted, if the probability is false then the sequencer will hold the last step voltage for the time defined in the current not outputted step.

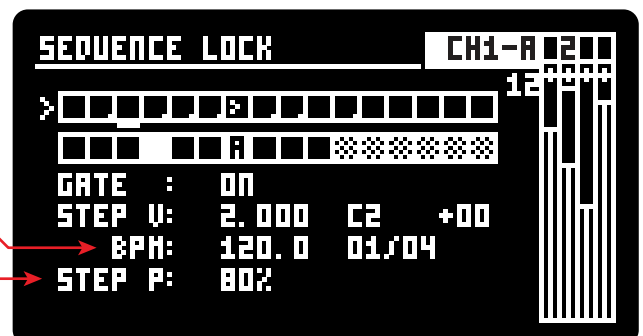
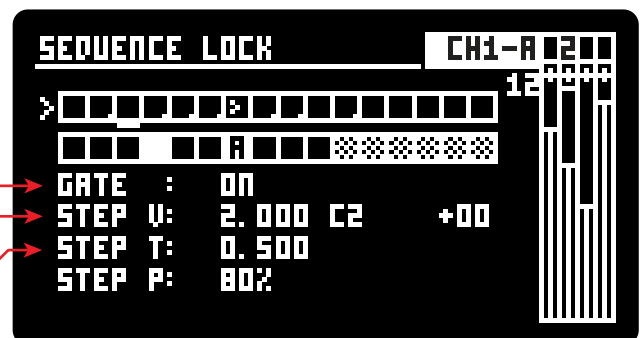

1. RANDOM VOLTAGE GENERATION

ADDAC511 User's Guide

LOCK : Transport Controls

STEPS GRAPHICS

Here's the different graphics used and their functions

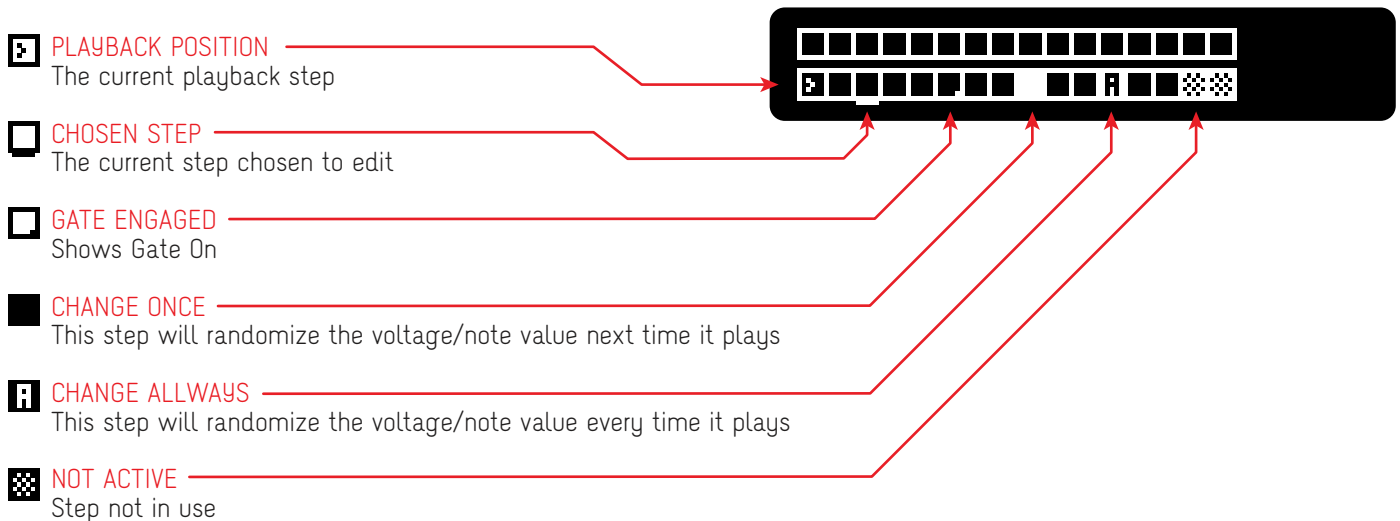

STEP SELECTION

With [ENCODER A] set the cursor on the grid then use [ENCODER B] to select the desired step.

SPECIAL CHANGES

Pressing [ENCODER B] when the cursor is on the grid will create Special Changes on the selected step. At each press it iterates between: normal step, change once or change allways.

EDITING STEPS

After selecting the step to edit then scroll to the parameter to edit with [ENCODER A], use [ENCODER B] to edit the GATE, STEP V, STEP T and STEP P values.

CURSOR POSITION AND SHOWN VALUES

if the cursor is selecting the grid then the values displayed will show the settings for the current step being played.

If the cursor is on a step value (GATE, STEP V, STEP T, STEP P) then it will show the selected step values, pressing [ENCODER B] advances to the next step.

STEP T

Step Time is dependent on the [TIME] mode selected in the Time Screen.

If BPM mode is selected the steps' time are defined as fractions (1/1, 1/2, 1/4...).

If TIME mode is selected the steps' time are defined in milliseconds.

LOCK : TRANSPOSITION

The user can transpose any programmed sequence simply by using the transpose features in the [QUANTIZER] screen.

2. RANDOM ENVELOPE GENERATION

ADDAC511 User's Guide

VOLTAGE SETTINGS : SIGNAL FLOW

ENVELOPE GENERATION

The envelope generation process is made of a number of functions in a chain. Each function features it's own fast recall push button and configuration screen. At every cycle a new Envelope will be generated by this chain.

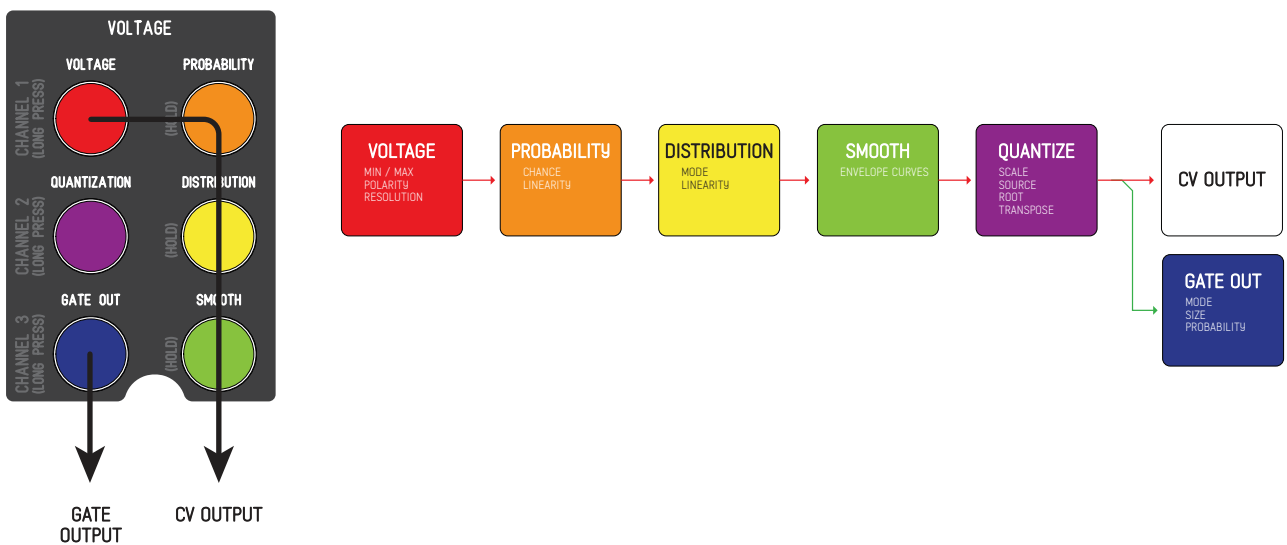

Here's an example plot of an Envelope generated output

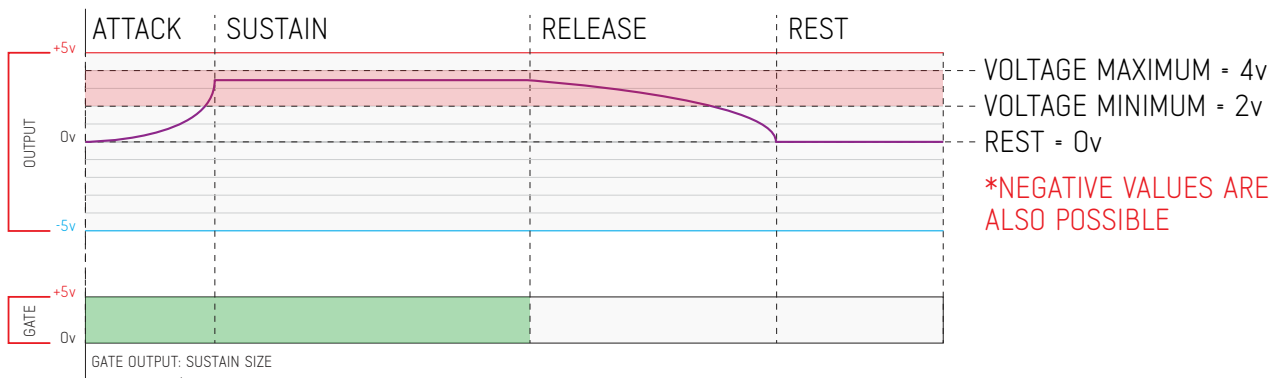

2. RANDOM ENVELOPE GENERATION

ADDAC511 User's Guide

ENVELOPE VOLTAGE SETTINGS

VOLTAGE SCREEN:

Voltage range settings

MODE

The channels' operating Mode

VOLTAGE MAXIMUM

Sets the maximum voltage of the randomization range

VOLTAGE MINIMUM

Sets the minimum voltage of the randomization range

VOLTAGE REST

Sets the voltage for when the envelope is in rest state

CV POLARITY

Sets a Positive (0 > +5V) or Bipolar range (-5V > +5V)

STEPS

Sets the number of steps to divide the MIN/MAX range defined from 2 to 320 or MAX (full 16bit resolution)

RANGE LOCK

OFF: [V. MAX] & [V. MIN] defines the range minimum and maximum boundaries independently
ON: Locks the current range defined, editing [V. MAX] will also change [V. MIN] and vice-versa.

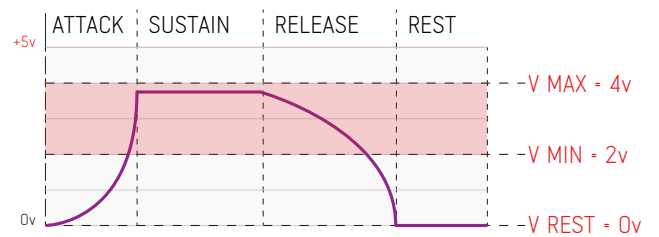
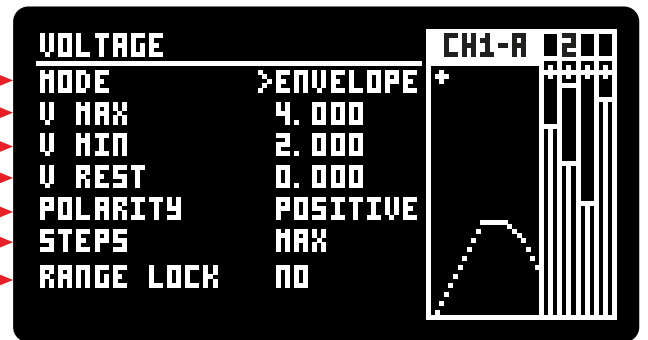

QUANTIZATION SCREEN (same as in voltage mode)

Voltage quantization settings same as in random mode

SCALE

Select from a few standard scales plus a custom setting where the user can freely choose the scale notes.

SOURCE

The source to be quantized, by default is set to the current channel although it can be set to any of the other channels or cv inputs working as a quantizer

ROOT NOTE

The scale Root note

TRANSCOPE MODE

SEMITONES: Transposition in semitones intervals
SCALE DEGREE: The scale degree transposition, transposes within the scale notes, in case of standard 7 note scales it can be used for modes:1-Ionian, 2-Dorian and so on.
OCTAVES: Transposition in octave intervals
CENTS: Transposition in cents intervals

TRANSCOPE

The transposition value

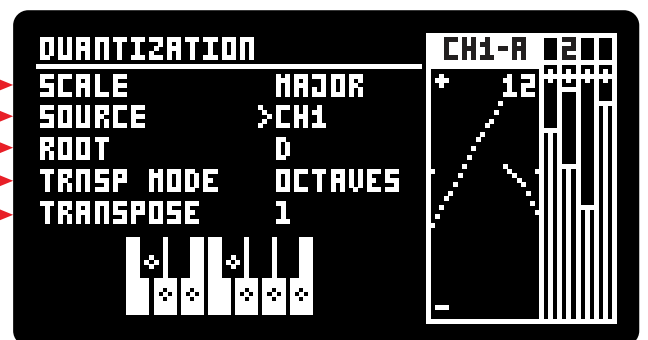

2. RANDOM ENVELOPE GENERATION

ADDAC511 User's Guide

ENVELOPE VOLTAGE SETTINGS

GATE OUT SCREEN

Settings control the Gate Out behaviour

SIZE

The Gate out length, it can be set to match the length of the envelope Attack (A), Attack and Sustain (AS) or Attack, Sustain and Release (ASR), as a 1ms or 10ms fixed output or as a percentage of the envelope overall length.

PROBABILITY

Output probability from 0% (no output) to 100% (always outputs). Also available is 1ms and 10ms for triggers.

SKIP STEPS

This feature introduces some disruption on the Gate Out behaviour, canceling it at every X steps.

OUTPUT ORDER

The order at which the CV and Gate is sent to the physical outputs. Although the time difference between the two outputs will still be microseconds apart this order may be important depending on what is being patched to.
CV/GATE: CV before the Gate Output
GATE/CV: Gate before the CV output

TRIGGER ON QUANTIZATION

When enabled it will output a 1ms Trigger at every new quantized note. It has no effect when Quantization is Off.

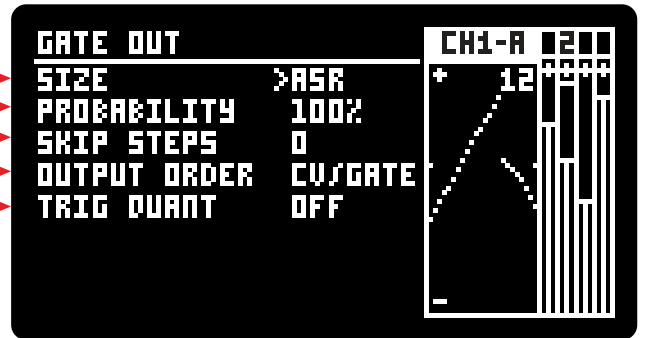

PROBABILITY SCREEN (same as in voltage mode)

Output probability settings, determines if it will generate a new CV at the current step or skip it and hold the current value until the next step.

PROBABILITY

Sets the probability of new generated voltages to be interrupted and not sent to the output
0% - All new voltages will be canceled
100% - No new voltages will be canceled

SKIP STEPS

This feature introduces some disruption on the CV output behaviour, skipping the CV generation at every X steps.

APPLY TO

CV: only applies the probability to the CV output. Gate Out will still be generated.
CV+GATE: applies the probability to both the CV and Gate output

LINEARITY

Sets the probability distribution curve

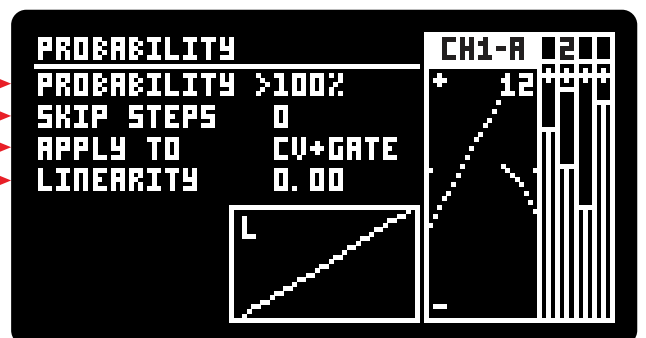

2. RANDOM ENVELOPE GENERATION

ADDAC511 User's Guide

ENVELOPE VOLTAGE SETTINGS

VOLTAGE DISTRIBUTION SCREEN (same as in voltage mode)

Allows for non-linear distribution of the voltage randomized

MODE

FREE

WALK

POSITION

Positions the distribution peak.

Q FACTOR

Sets the Q factor for the distribution curve.

LINEARITY

Sets the overall distribution curve.

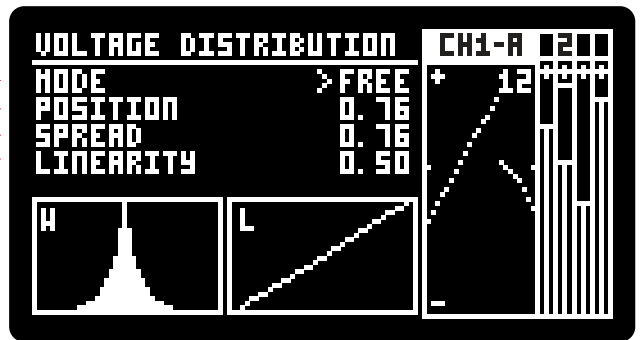

SMOOTH SCREEN

Settings control the Envelope shape

ATTACK CURVE

Sets the Attack curve from Log (1.00) to Exp (-1.00)

Linear at 0.00

RELEASE CURVE

Sets the Release curve from Log (1.00) to Exp (-1.00)

Linear at 0.00

ENVELOPE SHAPE VISUALIZATION

Here you can see the Envelope shape

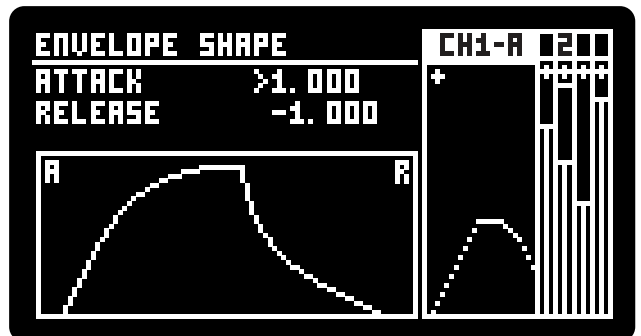
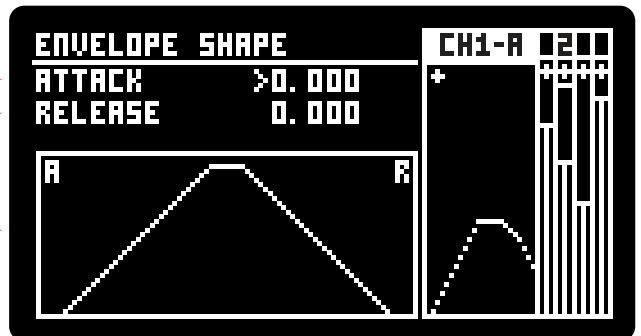

2. RANDOM ENVELOPE GENERATION

ADDAC511 User's Guide

QUANTIZING ENVELOPES

It is possible to quantize the envelope generated allowing arpeggio like effects.
Below you can see some graphical examples, here the quantizer is set to octaves for better readability
Quantized to: nearest note above.



TRIGGER ON QUANTIZATION

Ignores the [SIZE] setting and outputs
1ms Triggers at every new quantized note.

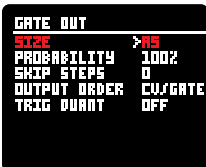
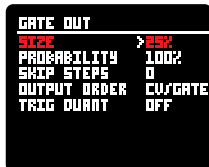
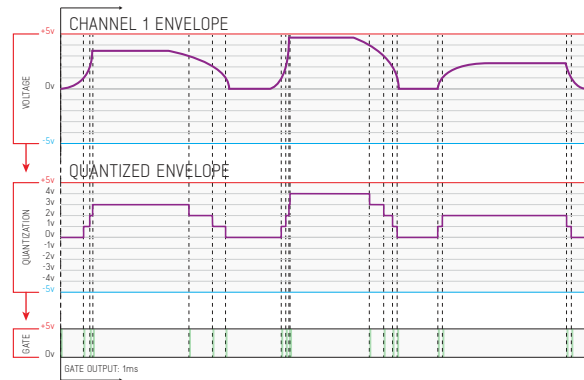
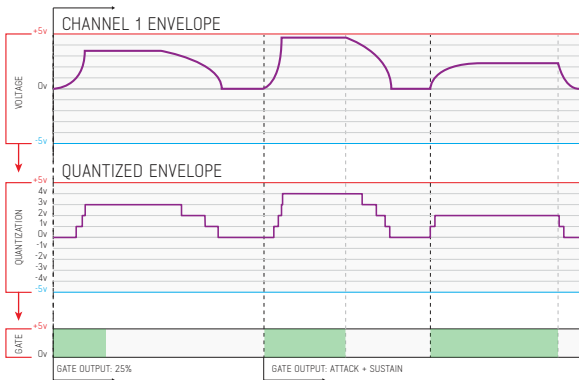

GATE SIZE

3 options:
Sync to Envelope: A, AS, ASR
Fixed size: 1ms or 10ms
As a percentage: 0% to 90%

2. RANDOM ENVELOPE GENERATION

ADDAC511 User's Guide

TIME SETTINGS : SIGNAL FLOW

TIMING GENERATION

Time settings determines the rate at which the voltage and gate are generated, the interval between every generation step is defined by the setting in the [TIME] screen, That value is then "balanced" by the [DISTRIBUTION] screen settings and a virtual clock tick is generated.

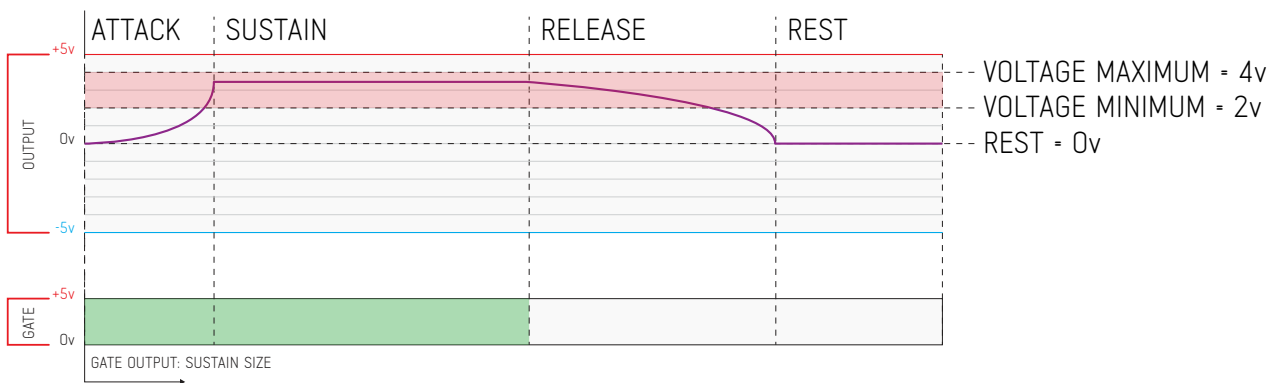
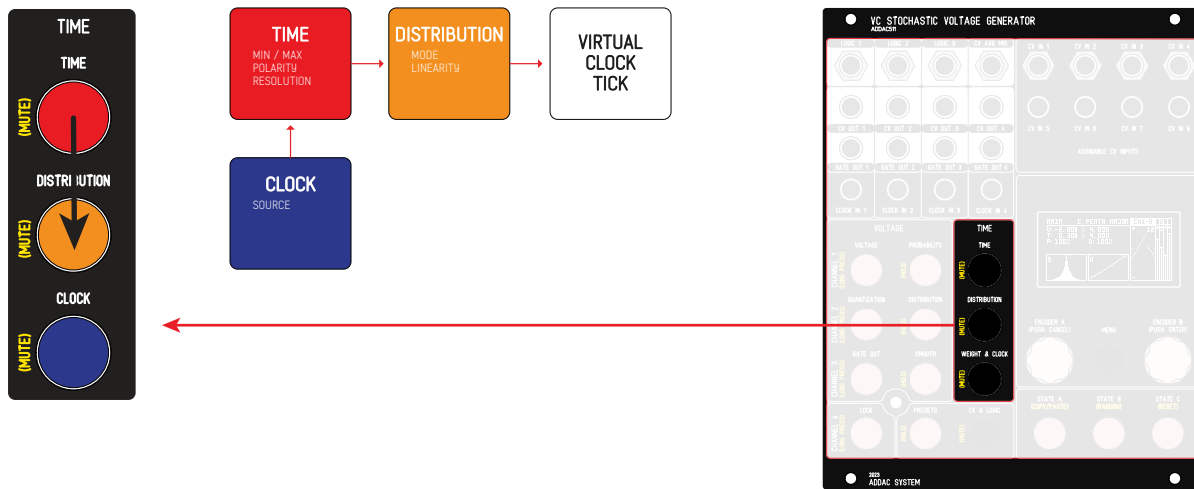

2. RANDOM ENVELOPE GENERATION

ADDAC511 User's Guide

TIME SETTINGS : TIME MODE (milliseconds)

In Time Mode the clock is defined in milliseconds, the step lengths will be randomized from the interval defined by the Minimum & Maximum parameters.
Setting the Minimum value higher than Maximum will result in a fixed time without any randomization.

TIME SCREEN:

TIME MODE

Sets the Time Mode to: Time or BPM

ATTACK MINIMUM & MAXIMUM

Sets the Attack Min & Max time in milliseconds.

SUSTAIN MINIMUM & MAXIMUM

Sets the Sustain Min & Max time in milliseconds.

RELEASE MINIMUM & MAXIMUM

Sets the Release Min & Max time in milliseconds.

REST MINIMUM & MAXIMUM

Sets the Release Min & Max time in milliseconds.

SCALE MINIMUM & MAXIMUM

Sets the Scale Min & Max multiplication factor.
This setting allows to stretch/compress the length of the envelope keeping the proportion of all time settings.
Here's an example of the same envelope shape with different scale settings.

TIME				CH1-A	1200
MODE	>TIME				
PARAM	MIN	MAX			
ATTACK	0.500	2.000	s		
SUSTAIN	0.500	2.000	s		
RELEASE	0.500	2.000	s		
REST	0.500	2.000	s		
SCALE	1.000	1.000	x		

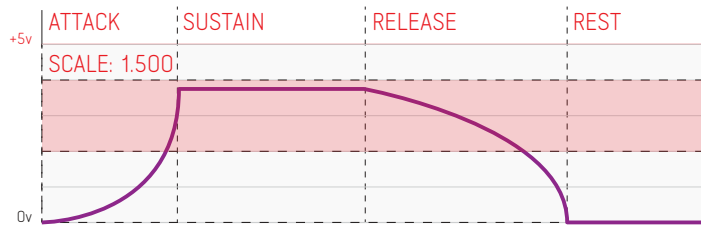
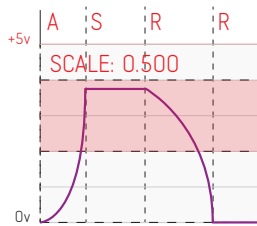
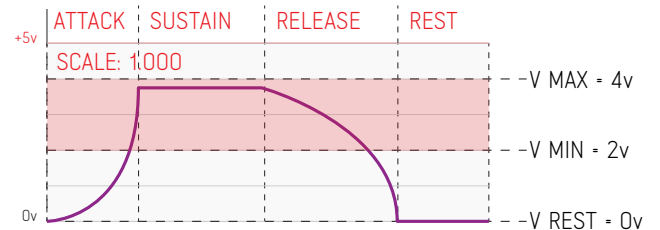

TIME DISTRIBUTION SCREEN

Allows for non-linear distribution of the randomized [TIME] screen settings.
Equally affects all random generations: Attack, Sustain, Release, Rest and Scale.

MODE

FREE
WALK

POSITION

Positions the distribution peak.

SPREAD

Sets the Q factor for the distribution curve.

LINEARITY

Sets the overall distribution curve.

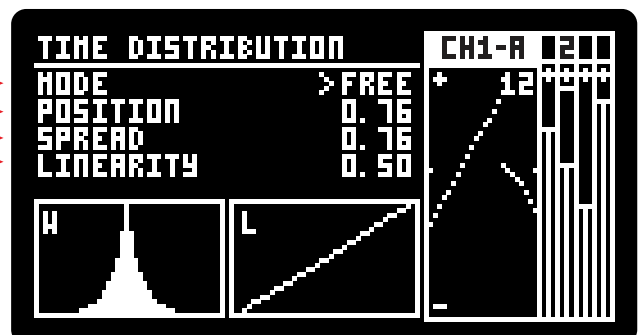

2. RANDOM ENVELOPE GENERATION

ADDAC511 User's Guide

CLOCK

CLOCK SCREEN (same as in voltage mode)

Configuring the selected channel's clock origin.

CLOCK SOURCE

Sets the origin of the Clock, options are:

INTERNAL (default): uses its own channel clock.

CHANNEL X: chooses one of the other channels clocks.

CLOCK IN X: chooses one of the 4 clock physical jack inputs

LOGIC X: chooses one of the 3 Logic outputs

INTERNAL

keeps the channel independent from other channels.

All other options makes the channel dependent to the source chosen. In these cases the clock parameters available will change according to the clock source selected.

CHANNEL 1 to 4

Syncs to any other channel: slave mode.

CLOCK IN 1 to 4

Uses the frontpanel clock inputs to sync to external sources.

CLOCK IN MODES:

GATE: In Gate mode it will sustain the envelope until the Gate goes off.

TRIGGER: In Trigger mode will not consider the trigger/gate length.

LOGIC 1 to 3

Uses the internal logic outputs as a clock.

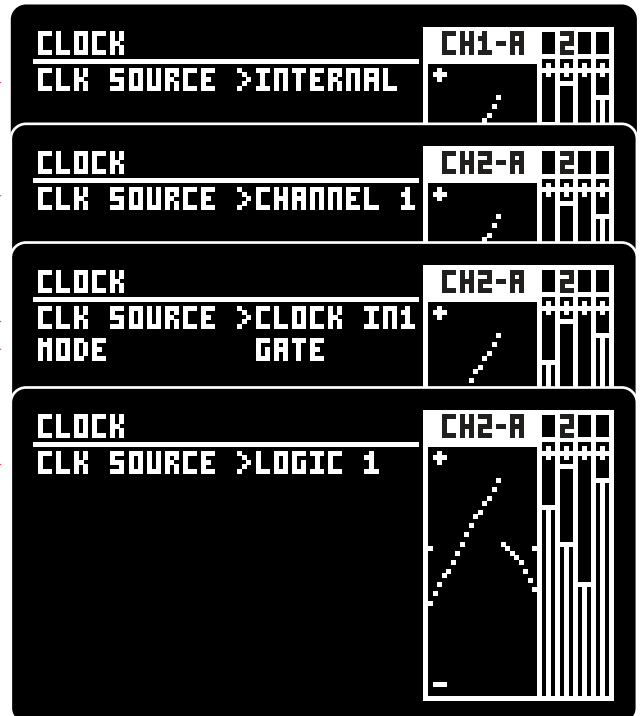

QUANTIZER

ADDAC511 User's Guide

QUANTIZER POTENTIAL

The Quantizing engine is extremely powerful and can be used in many creative ways. It features 16 bit DACs making it also very accurate.

Possibilities include linking all channels for chord generation or, using 4 CV inputs and 4 clock inputs, becomes a fully independent 4 channel quantizer, each with its own scale, outputting 4 CVs and 4 gate signals working as a fully featured 4 channel quantizer.

in the next pages we'll describe in detail all its possibilities.

SCALES:

As default we offer a few standard scales, we also added a custom setting where the user can freely choose the scale notes.

SOURCE

The source to be quantized, by default is set to the current channel although it can be set to any of the other channels or cv inputs working as a quantizer.

ROOT NOTE The scale Root note

TRANSPOSE MODE

SEMITONES: Transposition in semitones intervals
SCALE DEGREE: The scale degree transposition, transposes within the scale notes, in case of standard 7 note scales it can be used for modes:1-Ionian, 2-Dorian and so on.
OCTAVES: Transposition in octave intervals
CENTS: Transposition in cents intervals

TRANSPOSE

The transposition value

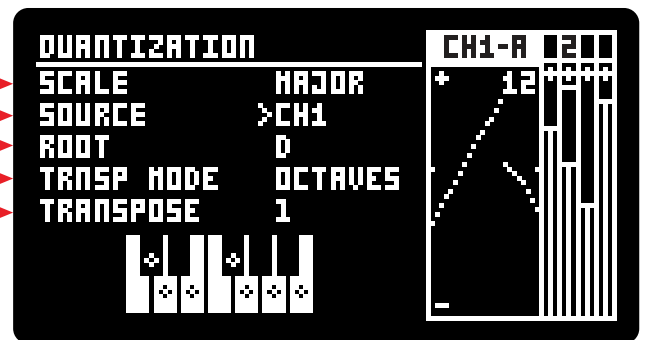

QUANTIZER ROUNDING

In the [MENU] the user can find a quantization rounding setting that will determine how the incoming voltage will be quantized:

NEAREST NOTE: Quantizes to the nearest note no matter if above or below.

NOTE ABOVE: Quantizes to the closest note above

NOTE BELLOW: Quantizes to the closest note bellow

NOTE PROBABILITY: Quantizes to a set of pre-defined probabilities

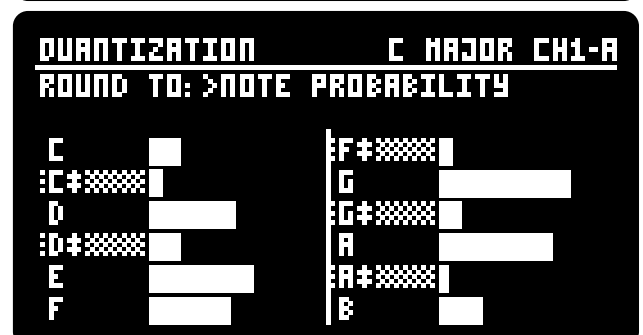
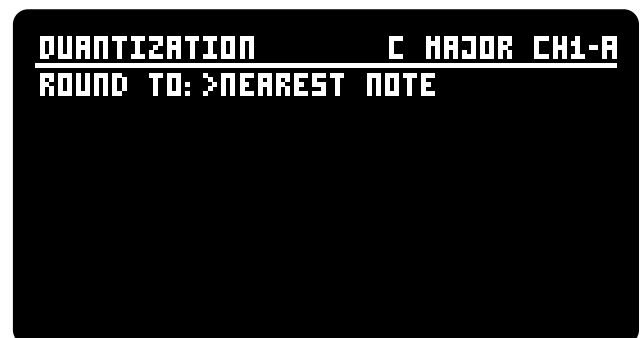

QUANTIZER

ADDAC511 User's Guide

INTERNAL vs. EXTERNAL QUANTIZATION

QUANTIZER SOURCES:

The Quantizing function is normally used following the channel's mode chain but it can be routed to accept any other channel or an external CV as its input allowing 4 quantization channels that can be linked in order to create chords or totally independent with different scales for each channels.

Changing the quantizer [SOURCE] to any other option than the channel's own input will render the channel's [VOLTAGE], [PROBABILITY] and [DISTRIBUTION] to be bypassed and will have no influence on the channel's output.

Bellow you can find examples and a diagram with both internal and external quantization.

SELF QUANTIZATION

QUANTIZING CHANNEL'S VOLTAGE GENERATION

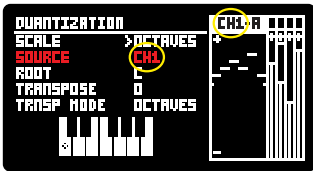

CHANNEL 1 QUANTIZING CHANNEL 1 VOLTAGE

OTHER CHANNELS QUANT.

QUANTIZING OTHER CHANNEL'S VOLTAGE

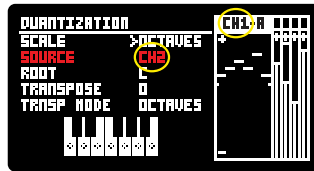

CHANNEL 1 QUANTIZING CHANNEL 2 VOLTAGE
CHANNEL 1 VOLTAGE GENERATION IS BYPASSED

EXTERNAL QUANTIZATION

QUANTIZING CV INPUTS

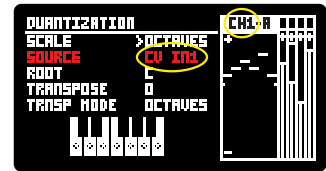

CHANNEL 1 QUANTIZING CV INPUT 1 VOLTAGE
CHANNEL 1 VOLTAGE GENERATION IS BYPASSED

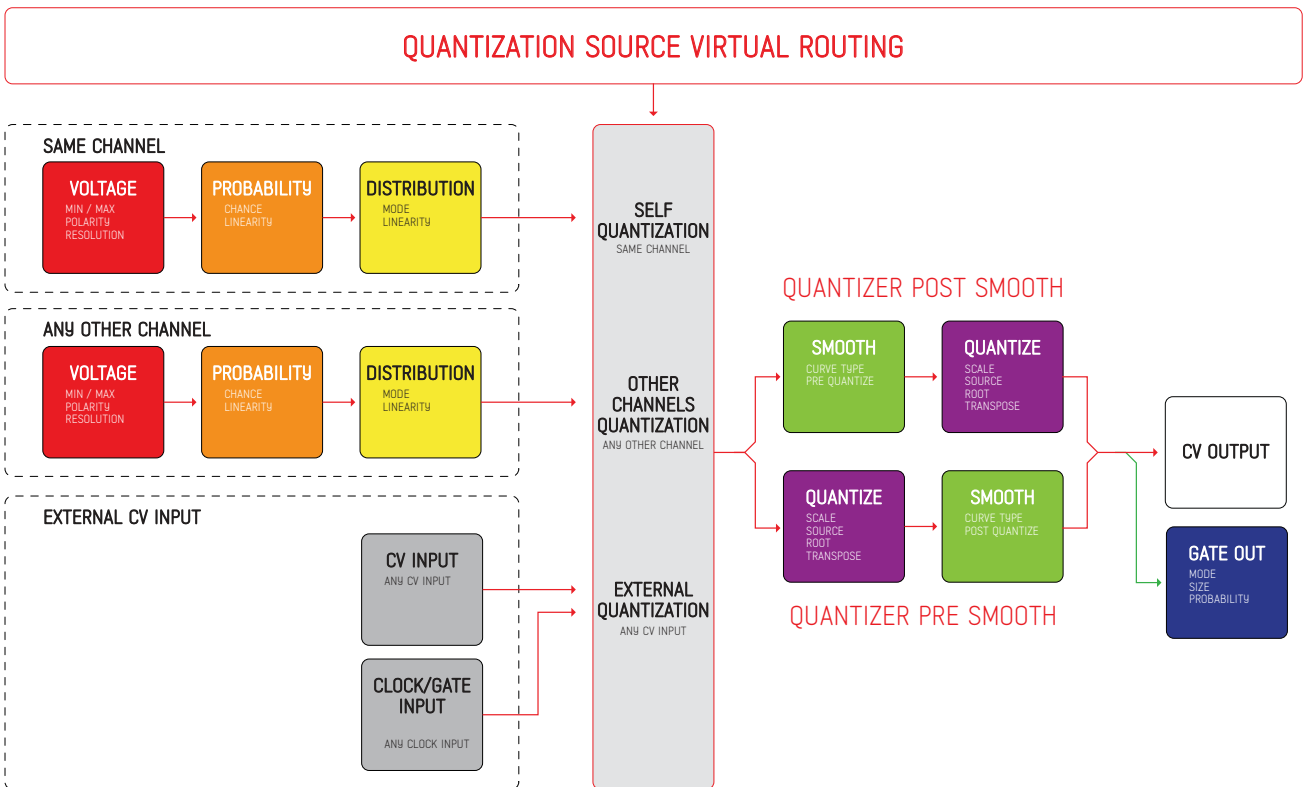

QUANTIZER

ADDAC511 User's Guide

QUANTIZER SOURCES GRAPHICAL EXAMPLES

Bellow you can find graphical examples with both internal and external quantization. Quantizer set to octaves for better readability. Quantized to closest note above.

```

QUANTIZATION
SCALE >OCTAVES
SOURCE CH1
ROOT C
TRANSPOSE 0
TRNSP MODE OCTAVES
    
```



SELF QUANTIZATION

QUANTIZING CH1 VOLTAGE GENERATION

Quantizer set to octaves for better readability.
Quantized to closest note above.

```

QUANTIZATION
SCALE >OCTAVES
SOURCE CH2
ROOT C
TRANSPOSE 0
TRNSP MODE OCTAVES
    
```



OTHER CHANNELS QUANTIZATION

QUANTIZING OTHER CHANNELS VOLTAGE

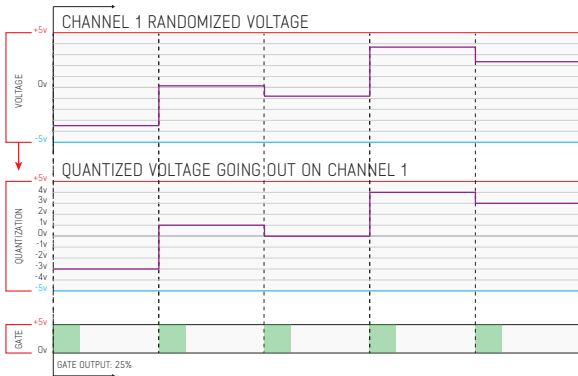

```

GATE OUT
SIZE 25%
PROBABILITY 100%
SKIP STEPS 0
OUTPUT ORDER CV/GATE
    
```

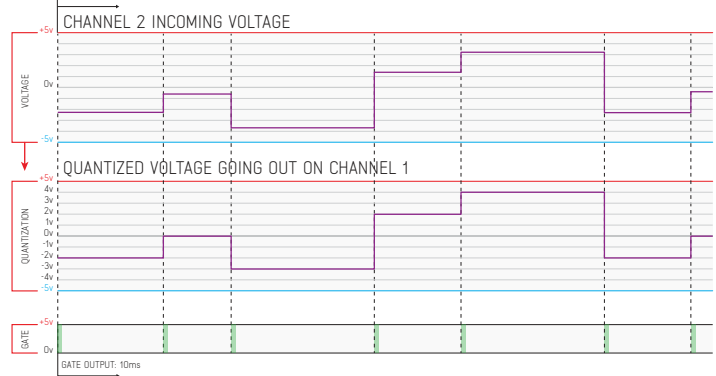

```

GATE OUT
SIZE 10ms
PROBABILITY 100%
SKIP STEPS 0
OUTPUT ORDER CV/GATE
    
```

```

QUANTIZATION
SCALE >OCTAVES
SOURCE CV IN1
ROOT C
TRANSPOSE 0
TRNSP MODE OCTAVES
    
```



EXTERNAL QUANTIZATION

QUANTIZING CV INPUT 1

```

CLOCK
CLR SOURCE >INTERNAL
CLK DELAY OFF
    
```

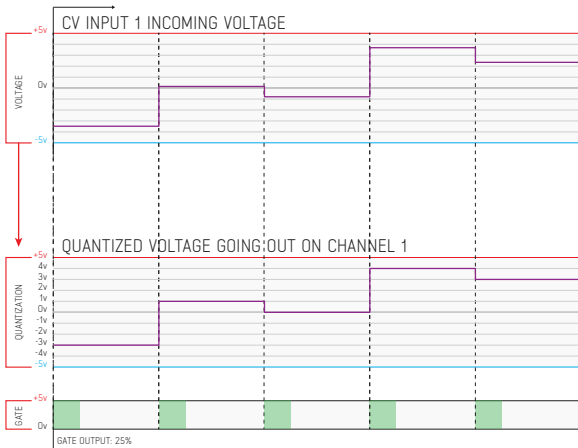

```

GATE OUT
SIZE 25%
PROBABILITY 100%
SKIP STEPS 0
OUTPUT ORDER CV/GATE
    
```

```

QUANTIZATION
SCALE >OCTAVES
SOURCE CV IN1
ROOT C
TRANSPOSE 0
TRNSP MODE OCTAVES
    
```



EXTERNAL QUANTIZATION WITH GATE INPUT

QUANTIZING CV INPUT 1 USING CLOCK IN 1

```

CLOCK
CLR SOURCE >CLOCK IN1
CLK DELAY OFF
    
```

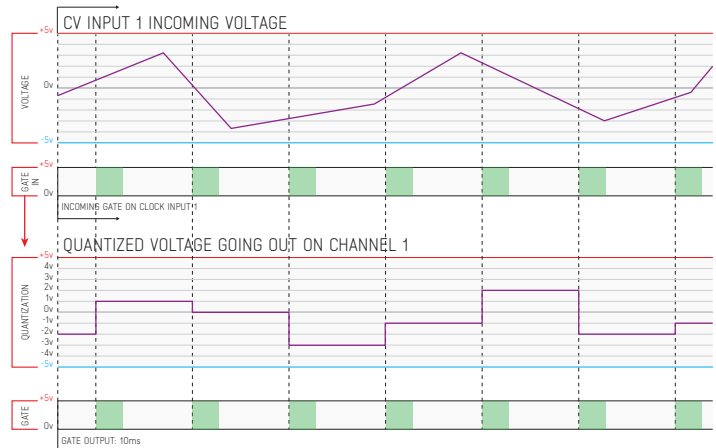

```

GATE OUT
SIZE 10ms
PROBABILITY 100%
SKIP STEPS 0
OUTPUT ORDER CV/GATE
    
```

QUANTIZER

ADDAC511 User's Guide

QUANTIZER ROUNDING & NOTE PROBABILITY

Bellow you can find graphical examples with all 3 quantizer rounding standards as well as the note probability method

STANDARD QUANTIZER ROUNDING

Quantizer set to octaves of C and voltage range restricted to 2V

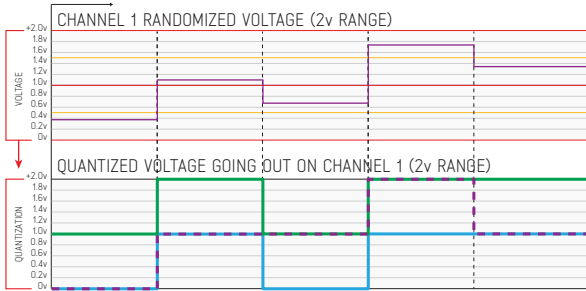
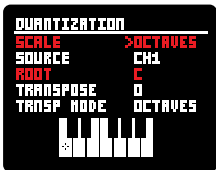

The incoming voltage in this case will be quantized to C Octaves, meaning the output will be a multiple of 1v (0v, 1v, 2v, 3v, 4v)

If a voltage of 1.2v is detected then:
 Closest note above will be: 2v
 Nearest note will be: 1v
 Closest note below will be: 1v

If a voltage of 1.7v is detected then:
 Closest note above will be: 2v
 Nearest note will be: 2v
 Closest note below will be: 1v

ROUNDING TO NOTE PROBABILITY

Quantizer set to Major C and voltage range restricted to 2V

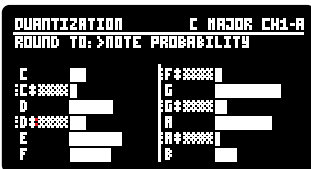
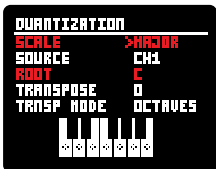

Note Probability rounding will force quantization to a set of note defined probabilities. The incoming voltage only defines the octave output, the probability outcome will set the note. The note in this case can be furthest from the incoming voltage. Notes not present in the selected scale appear checked.

If a voltage of 1.2v is detected then:
 The output will be any note in the Major C scale in the octave between 1v and 2v.

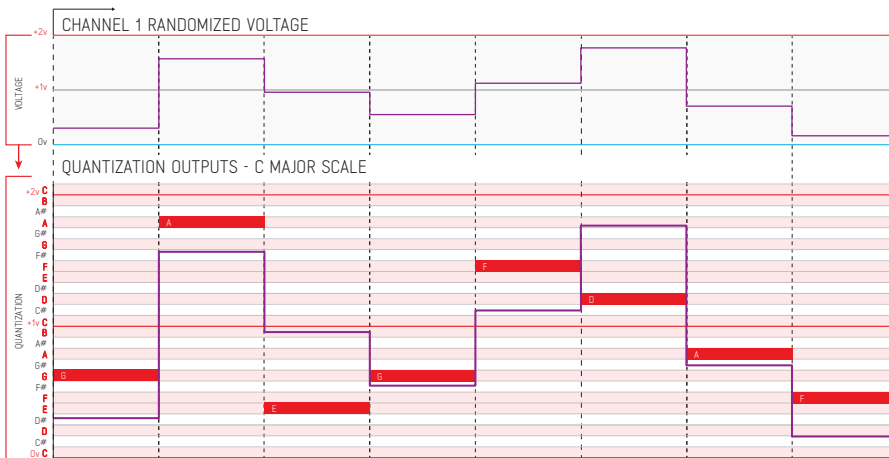

QUANTIZER

ADDAC511 User's Guide

QUANTIZER PRE / POST SMOOTH

The [SMOOTH] and [QUANTIZE] order (A to B, B to A) can be altered in the [SMOOTH] window.
 QUANTIZER PRE SMOOTH will result in glide effects
 QUANTIZER POST SMOOTH will result in arpeggio effects

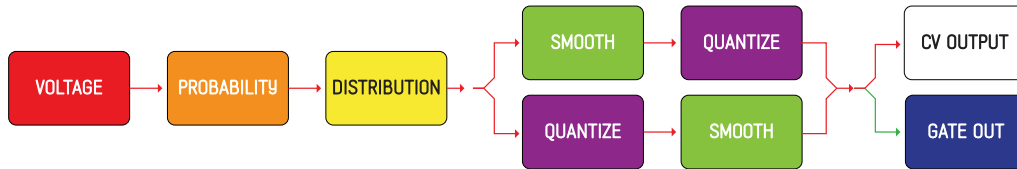

Below you can see some graphical examples with both options
 Quantizer set to octaves for better readability
 On the bottom right you'll find an example of the [TRIGGER GATE] function.

QUANTIZER PRE SMOOTH

```

SMOOTH
CURVE TYPE >LIN
DURATION 50%
QUANTIZE PRE
RESOLUTION 16 BIT
TRIGGER GATE NO
STEP MODE OFF
    
```

Smooth duration set to 50%

```

QUANTIZATION
SCALE >OCTAVES
SOURCE CH1
ROOT C
TRANSPOSE 0
TRASP MODE OCTAVES
    
```

QUANTIZE SOURCE
 Quantizer set to octaves (for better graphical readability below).
 Quantized to: nearest note.

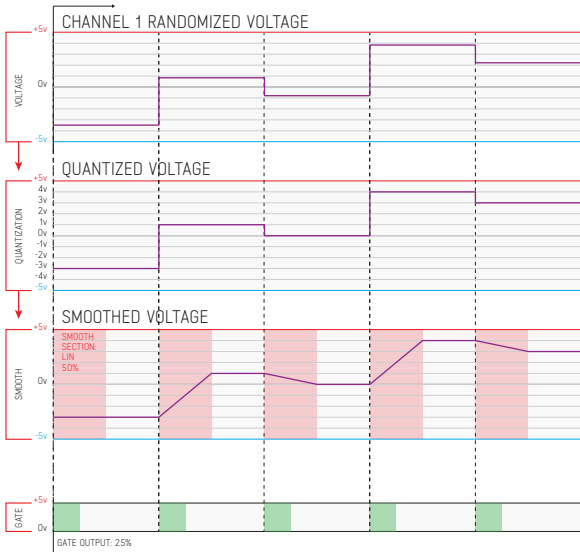

```

GATE OUT
SIZE 25%
PROBABILITY 100%
SKIP STEPS 0
OUTPUT ORDER CV/GATE
    
```

Gate size set to 25%

QUANTIZER POST SMOOTH

```

SMOOTH
CURVE TYPE >LIN
DURATION 50%
QUANTIZE POST
RESOLUTION 16 BIT
TRIGGER GATE NO
STEP MODE OFF
    
```

```

QUANTIZATION
SCALE >OCTAVES
SOURCE CH1
ROOT C
TRANSPOSE 0
TRASP MODE OCTAVES
    
```

QUANTIZE SOURCE
 Quantizer set to Major scale.
 Quantized to: nearest note.

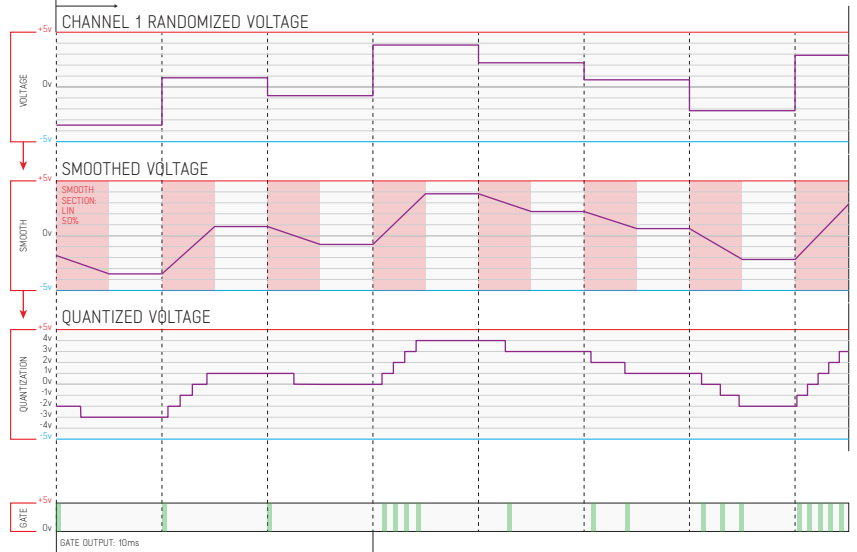

```

GATE OUT
SIZE 100%
PROBABILITY 100%
SKIP STEPS 0
OUTPUT ORDER CV/GATE
    
```

```

SMOOTH
CURVE TYPE >LIN
DURATION 50%
QUANTIZE POST
RESOLUTION 16 BIT
TRIGGER GATE YES
STEP MODE OFF
    
```

TRIGGER GATE
 Gate Out triggered at every quantized CV change.

QUANTIZER

ADDAC511 User's Guide

EXTERNAL QUANTIZER

When quantizing external CV inputs the smooth effect will be bypassed.

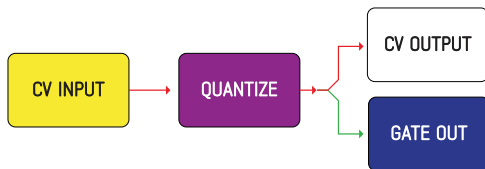

Below a graphical example

QUANTIZING WITH INTERNAL CLOCK

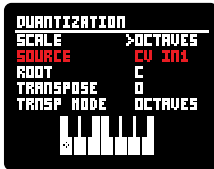

INT. CLOCK

Using the internal Clock to quantize the cv input at the rate defined.

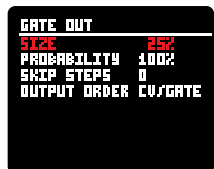
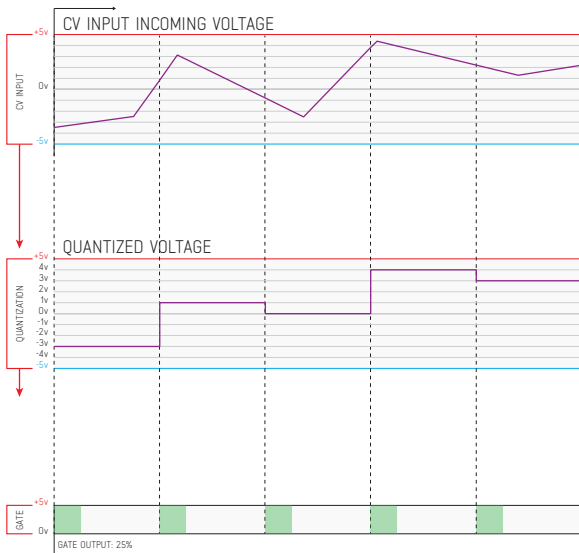
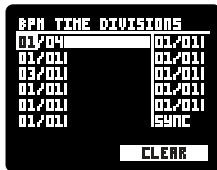

QUANTIZING WITH EXTERNAL CLOCK

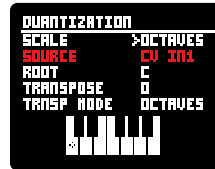

EXT. CLOCK

When set to Clock In there are two quantization modes: Real-time and Locked

REAL-TIME

Once the user chooses a clock input the quantization will start working in real-time. no clock is used, the quantization happens as a new value is detected.

EXTERNAL CLOCK

Once the clock input receives a Gate input the quantization will sync to and be clocked by the Gate input. To go back to real-time choose internal clock and then Clock In once again.

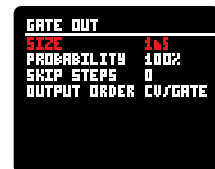
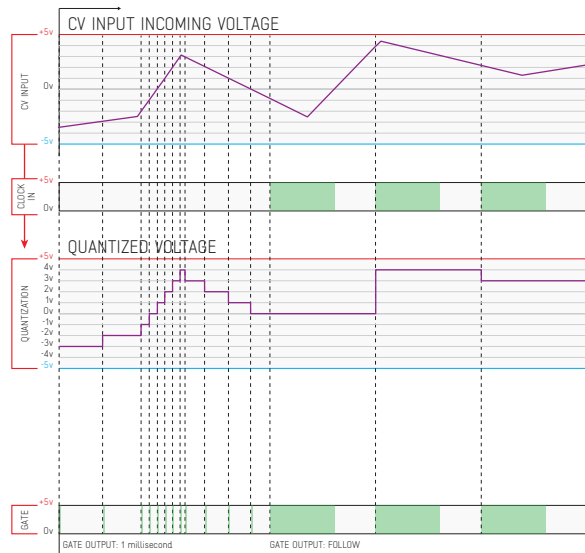

FOLLOW

When the Gate Out size is set to Follow the Gate Out will have the same size as the Clock Input.

QUANTIZER TRANSCOPE

There are 4 Transposition modes:

CENTS

Microtonal detune, -50 to +50 cents.
The Cents mode is cumulative with any of the next 3 modes

SEMITONES

Semitone transposition

SCALE DEGREES

Transposition within the scale selected

OCTAVES

Octave transposition

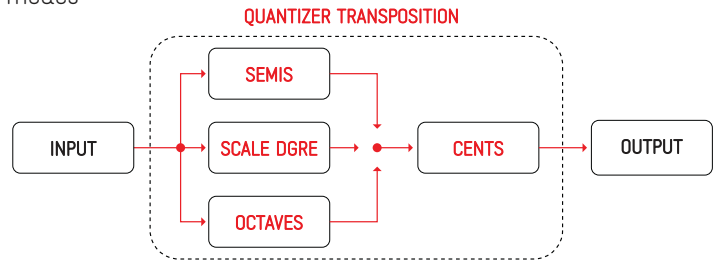

<p>QUANTIZATION</p> <p>SCALE >PENTA MAJ</p> <p>SOURCE CH1</p> <p>ROOT C</p> <p>TRNSP NODE OCTAVES</p> <p>TRANSCOPE 0</p>	<p>QUANTIZATION</p> <p>SOURCE >OUT1</p> <p>SCALE PENTA MAJ</p> <p>ROOT C</p> <p>TRNSP NODE CENTS</p> <p>TRANSCOPE +50</p>	<p>QUANTIZATION</p> <p>SOURCE >OUT1</p> <p>SCALE PENTA MAJ</p> <p>ROOT C</p> <p>TRNSP NODE SEMIS</p> <p>TRANSCOPE +1</p>	<p>QUANTIZATION</p> <p>SOURCE >OUT1</p> <p>SCALE PENTA MAJ</p> <p>ROOT C</p> <p>TRNSP NODE SCALE DGRE</p> <p>TRANSCOPE +1</p>	<p>QUANTIZATION</p> <p>SOURCE >OUT1</p> <p>SCALE PENTA MAJ</p> <p>ROOT C</p> <p>TRNSP NODE OCTAVES</p> <p>TRANSCOPE +1</p>
------------------------------------------------------------------------------------------------------------------------------------	-------------------------------------------------------------------------------------------------------------------------------------	------------------------------------------------------------------------------------------------------------------------------------	-----------------------------------------------------------------------------------------------------------------------------------------	--------------------------------------------------------------------------------------------------------------------------------------

C MAJOR PENTATONIC - E NOTE EXAMPLE

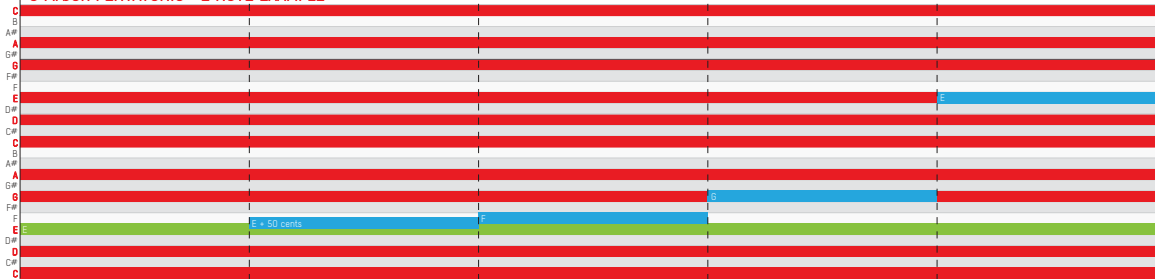

E Note
No Transposition E Note +50 Cents E Note +1 Semi E Note - F E Note - G E Note 2nd Degree E Note +1 Octave

C MAJOR PENTATONIC - SMALL PATTERN EXAMPLE

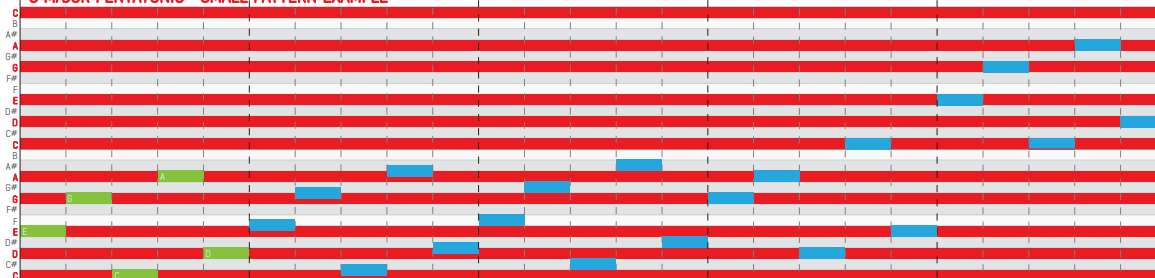

No Transposition +50 Cents +1 Semi 2nd Degree +1 Octave

QUANTIZER : CHORD GENERATION EXAMPLE

CHANNEL 1

GENERATING CHORD ROOT NOTE

MAIN SCREEN

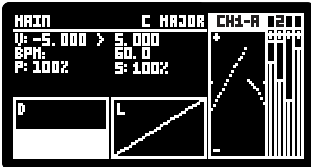

VOLTAGE SETTINGS

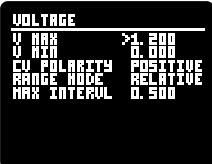

TIME SETTINGS

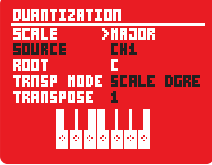
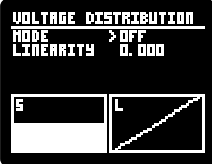
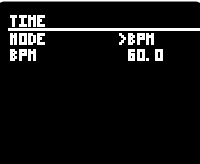

CHANNEL 2

3rd SCALE DEGREE

MAIN SCREEN

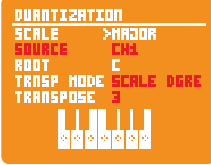
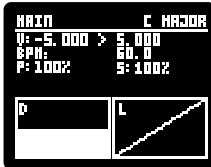

CHANNEL 3

5th SCALE DEGREE

MAIN SCREEN

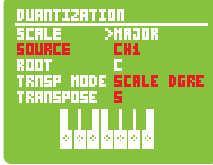
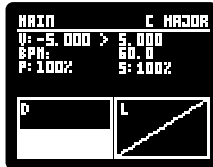

CHANNEL 4

7th SCALE DEGREE

MAIN SCREEN

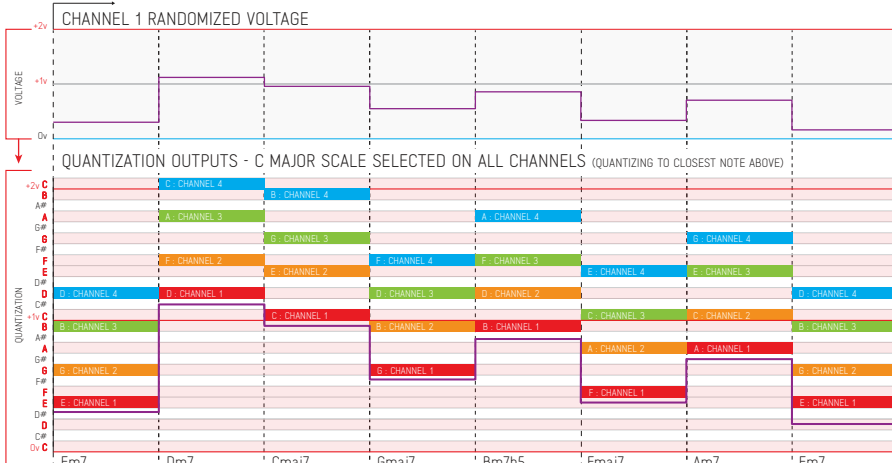
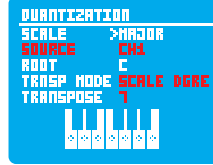
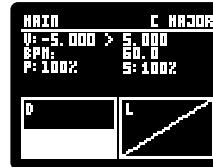

4 NOTE CHORDS

C Major scale is chosen for all channels. Channel 1 is used to generate the chord root note. Channels 2, 3 and 4 get their Clock and Quantization source from Channel 1. Channels 2, 3 and 4 transpose the incoming Channel 1 root note to its 3rd, 5th and 7th degree, generating chords always in the scale. The transpose values can be independently assigned to different CV inputs to be modulated.

PRESETS

Every Preset stores all info of all channels. There are 16 slots available, these can be downloaded as a one single file Bank to a computer allowing users to manage their Banks in the computer.

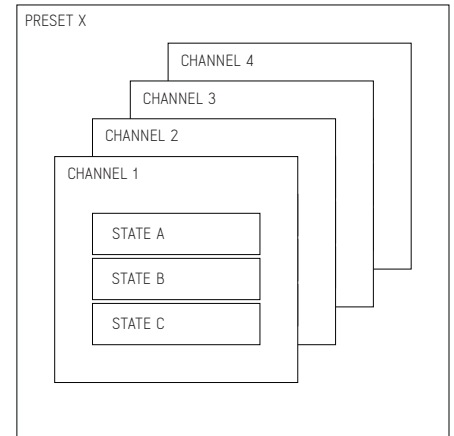

The Presets screen allows to scroll through the list with any of the Encoders and Load or Save by pressing the respective Left / Right Encoder.

There are 75 available slots to save Presets.



SAVING

When saving the user can select the preset name using the Encoders: Left Encoder selects which character to edit, Right Encoder selects the character.



CV ASSIGNMENTS

There are 8 CV Inputs on the top right corner of the module which can be assigned to any parameter of any output channel.
To assign them just enter the Assign Screen and press the Right Encoder to ADD a new assign.

Here's the description of all configuration settings:

- INPUT CHANNEL** — The CV Input channel to be used
- CHANNEL TO ASSIGN** — The channel to be affected by the CV input
- FUNCTION** — The function to be affected by the CV input
- INPUT GAIN** — The Gain of the CV Input, from 0 to times 10
- OFFSET** — The Offset applied to the CV Input, from -1.0 to 1.0
- PHASE INVERSION** — Invert the Phase of the incoming signal

In this screen rotating the Left encoder chooses the parameter to edit, rotating the Right Encoder edits the parameter value.

Once configured pressing the Enter button (right encoder) saves the settings, exits to the main screen and displays the assign as a new line.

The same input can be assigned to multiple functions becoming more like a macro controller.

Fifty assignments can be added.

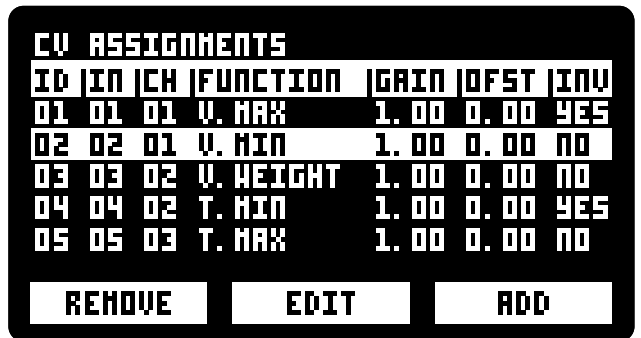

CV ASSIGNMENTS

ENCODERS INTERACTION

The virtual buttons on the screen show the current function for what the encoders will do when pressed.

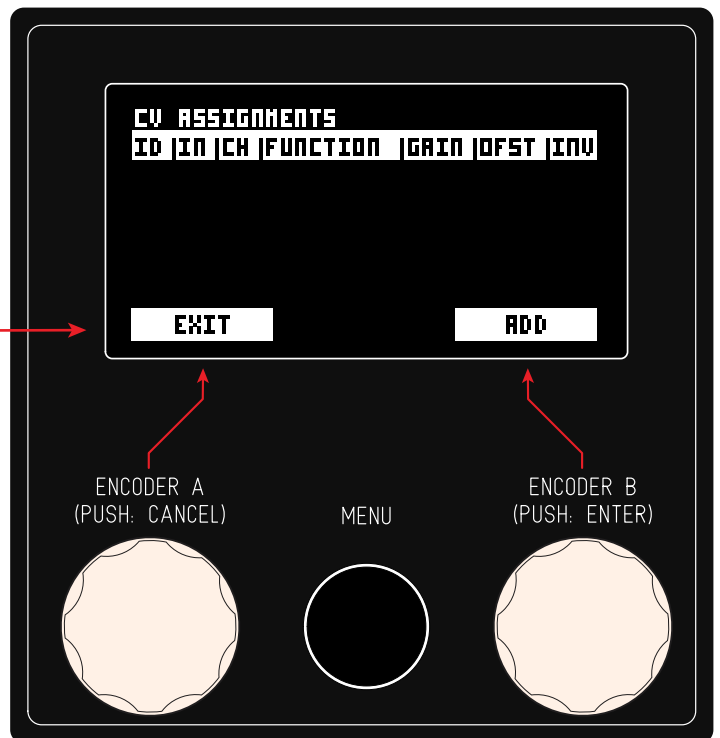

Rotating any of the Encoders will select and scroll through already assigned lines. Selected line appears with white background

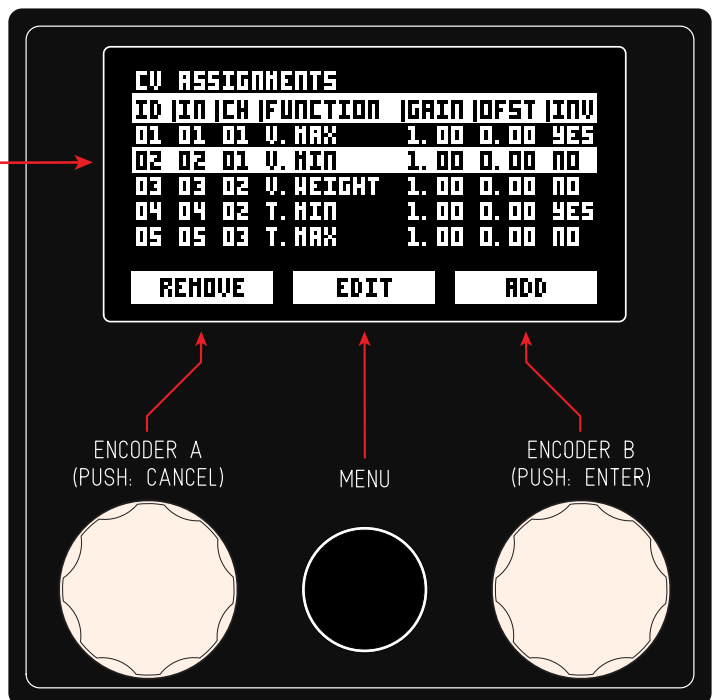

CV ASSIGNMENTS - FUNCTIONS

CV assignments allow to access most functions on the 511, due to space available these names were shortened, here's a list of the functions and how they appear on the display:

VMIN VOLTAGE MINIMUM (NORMAL & ENVELOPE)
 VMAX VOLTAGE MAXIMUM (NORMAL & ENVELOPE)
 VSTEPS VOLTAGE STEPS

QSCALE QUANTIZER SCALE
 QSRC QUANTIZER SOURCE
 QROOT QUANTIZER ROOT NOTE
 QMODE QUANTIZER TRANSPOSE MODE
 QSTEPS QUANTIZER TRANSPOSE STEPS

GATE SIZE GATE LENGTH
 GATE PROB GATE PROBABILITY
 TRG QUANT TRIGGER OUT AT NEW QUANTIZATION

PROB PROBABILITY
 PROBSTPS PROBABILITY SKIP STEPS
 PROBAPP PROBABILITY APPLY TO (CV/CV+GATE)
 PROBLIN PROBABILITY LINEARITY

DISTMODE DISTRIBUTION MODE
 DISTPOS DISTRIBUTION POSITION
 DISTSPREAD DISTRIBUTION SPREAD (Q)
 DISTLIN DISTRIBUTION LINEARITY

SMCURVE SMOOTH CURVE TYPE
 SMDUR SMOOTH DURATION
 SMQUAPP SMOOTH QUANTIZER ORDER PRE/POST
 SMRES SMOOTH RESOLUTION
 SMSTMOD SMOOTH STEP MODE
 SMSTEPS SMOOTH SKIP STEPS

TMODE TIME MODE (TIME/BPM)
 TMIN TIME MINIMUM
 TMAX TIME MAXIMUM
 TBPM TIME BPM

TDMODE TIME DISTRIBUTION MODE
 TDPOS TIME DISTRIBUTION POSITION
 TDSPREAD TIME DISTRIBUTION SPREAD (Q)
 TDLIN TIME DISTRIBUTION LINEARITY

"CLKSRC" CLOCK SOURCE
 CLKMULTDIV CLOCK MULTIPLIER/DIVIDER
 CLKFOLL CLOCK FOLLOW CH (BPM/OUT)
 CLKUSET CLOCK USE TIME (DELAY)
 SYNCBPM CLOCK SYNC BPM

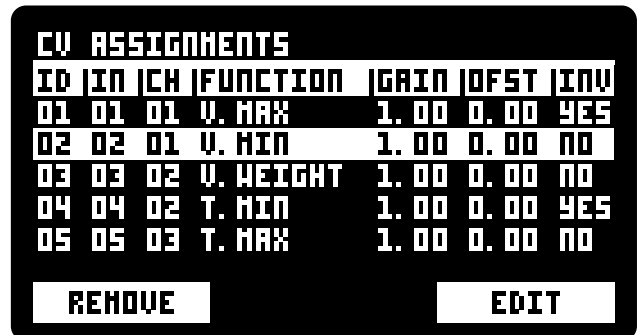

E REST V ENV. REST VOLTAGE
 E AMIN ENV. TIME ATTACK MIN
 E AMAX ENV. TIME ATTACK MAX
 E SMIN ENV. TIME SUSTAIN MIN
 E SMAX ENV. TIME SUSTAIN MAX
 E RMIN ENV. TIME RELEASE MIN
 E RMAX ENV. TIME RELEASE MAX
 E RTMIN ENV. TIME REST MIN
 E RTMAX ENV. TIME REST MAX
 E SCAL MIN ENV. SCALE MIN
 E SCAL MAX ENV. SCALE MAX
 E ASHAPE ENV. ATTACK SHAPE
 E RSHAPE ENV. RELEASE SHAPE
 E SIZE ENV. SIZE

HOLD HOLD STATE
 MUTE MUTE STATE
 STATE STATE CV
 STATE A STATE A
 STATE B STATE B
 STATE C STATE C

L PLAY LOCK: PLAY
 L PLAYALL LOCK: PLAY ALL
 L STOP LOCK: STOP
 L STOPALL LOCK: STOP ALL
 L RESET LOCK: RESET
 L RSTALL LOCK: RESET ALL
 STEP SELECT LOCK: SELECT STEP
 STEP VOLT LOCK: SELECTED STEP VOLTAGE
 STEP TIM LOCK: SELECTED STEP TIME MILLIS
 STEP NUM LOCK: STEP TIME NUMERATOR
 STEP DIV LOCK: STEP TIME DENOMINATOR
 STEP NOTE LOCK: SELECTED STEP NOTE
 STEP CENTS LOCK: SELECTED STEP CENTS

LOGIC ASSIGNMENTS

There are 3 Logic Outputs, pressing the [CV & LOGIC] button iterates through each Logic screen, you can see the selected Logic on the top left corner of the screen.

Logic operations compare 2 variables and output a true or false statement. Think of it as a gate output where true will output +5V, false outputs 0V.

The user can configure these operations with any of the CV inputs, Clock Inputs, CV outputs or Logic outputs. So it can be used to process External sources as well as internal sources.

When CV sources are used the logic threshold is 2.5v, crossing the threshold while rising or falling triggers the logic comparison.

Besides Logic operations these outputs can also be configured as counters or clock outputs.

To assign them just enter the Logic Assignment Screen, select the channel page, press the right encoder to ADD a new assign:

OPERATION

The Operation to be performed: NOT, AND, NAND, OR, NOR, XOR, XNOR, COUNTER, CLOCK OUTPUT

CHANGE

Change defines which variable triggers the logic comparison: ON X ONLY, ON X & Y

VARIABLE X

The source to be used for Input X

VARIABLE Y

The source to be used for Input Y

In this screen rotating the Left encoder chooses the parameter to edit, rotating the Right Encoder edits the parameter value.

Once configured pressing the ADD button [ENCODER B] saves the settings and will display the assign as a new line in the main Logic Assignments screen

The output is the result of all lines added.

TRUTH TABLE

Adding more than one line allows for more complex Logic operations. When setting a second line choosing OP1 (Operation 1) uses the result from the first operation as an input for the second operation.

Logic operations on wikipedia:
https://en.wikipedia.org/wiki/Logic_gate

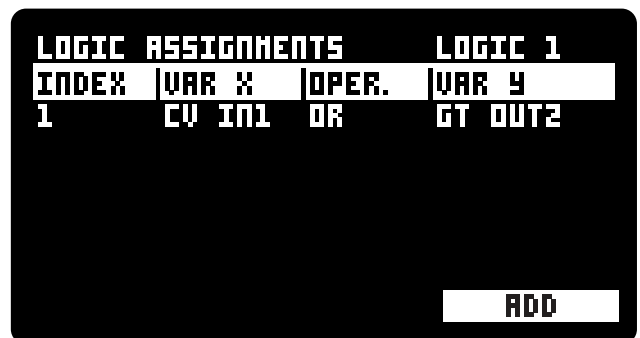
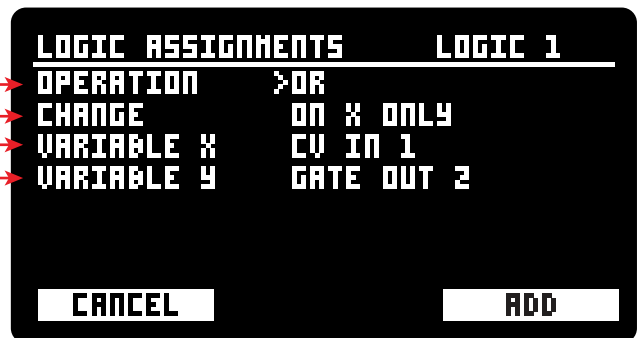
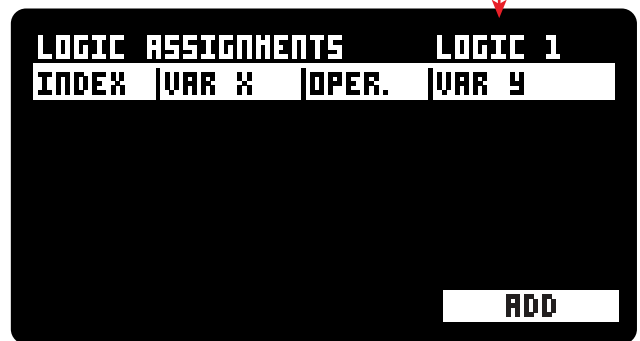

INPUT		OUTPUT					
X	Y	AND	NAND	OR	NOR	XOR	XNOR
0	0	0	1	0	1	0	1
0	1	0	1	1	0	1	0
1	0	0	1	1	0	1	0
1	1	1	0	1	0	0	1

LOGIC ASSIGNMENTS

EXAMPLES OF LOGIC OPERATIONS

Notice that NOT operations only use input variable X and simply inverts the input signal.

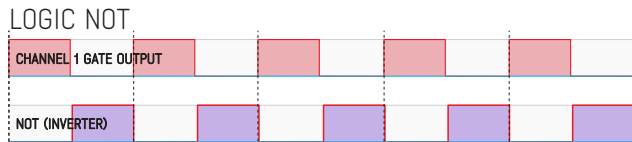

LOGIC ASSIGNMENTS			LOGIC 1
INDEX	VAR X	OPER.	VAR Y
1	GT OUT1	NOT	

ADD

Here we configured one logic output to compare Gate output 1 and Gate output 2. Below you can find graphical examples of all possible operations.

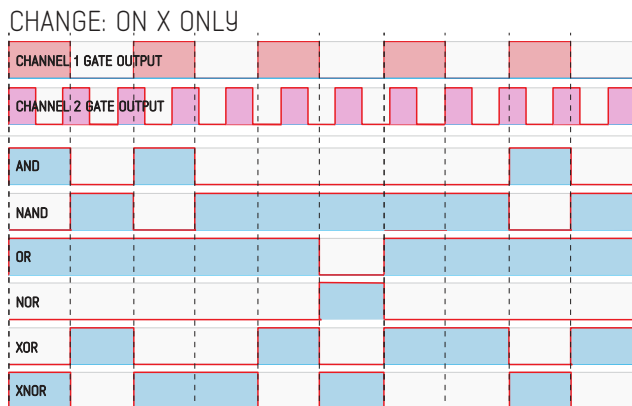

LOGIC ASSIGNMENTS			LOGIC 1
INDEX	VAR X	OPER.	VAR Y
1	GT OUT1	OR	GT OUT2

ADD

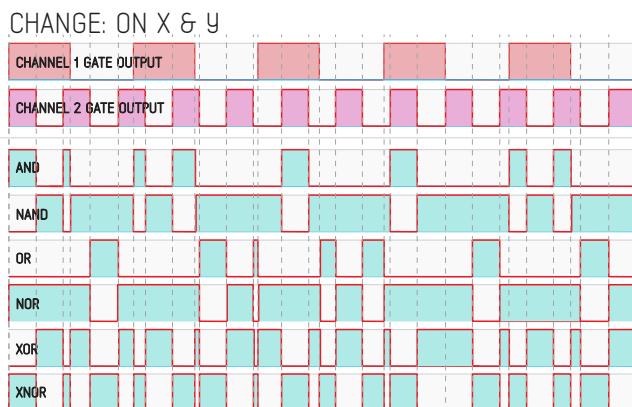

LOGIC ASSIGNMENTS

CASCADING OPERATIONS

Adding more than one line allows for more complex Logic operations. When setting a second line choosing OP1 (Operation 1) uses the result from the first operation as an input for the second operation. It is also possible to choose other Logic channels to cascade between channels.

Below a graphical example of this process with the configuration shown on the left.

LOGIC ASSIGNMENTS			LOGIC 1
INDEX	VAR X	OPER.	VAR Y
1	GT OUT1	NAND	GT OUT2
2	OP1	AND	GT OUT3
3	OP2	XOR	GT OUT4

REMOVE EDIT ADD

ENCODERS INTERACTION

Rotating any of the Encoders will scroll through already assigned lines. The virtual buttons on the screen show the current function for what the encoders are [MENU] button will do when pressed.

To exit this screen press any other function button.

ALL OPERATIONS SET TO CHANGE ON X & Y

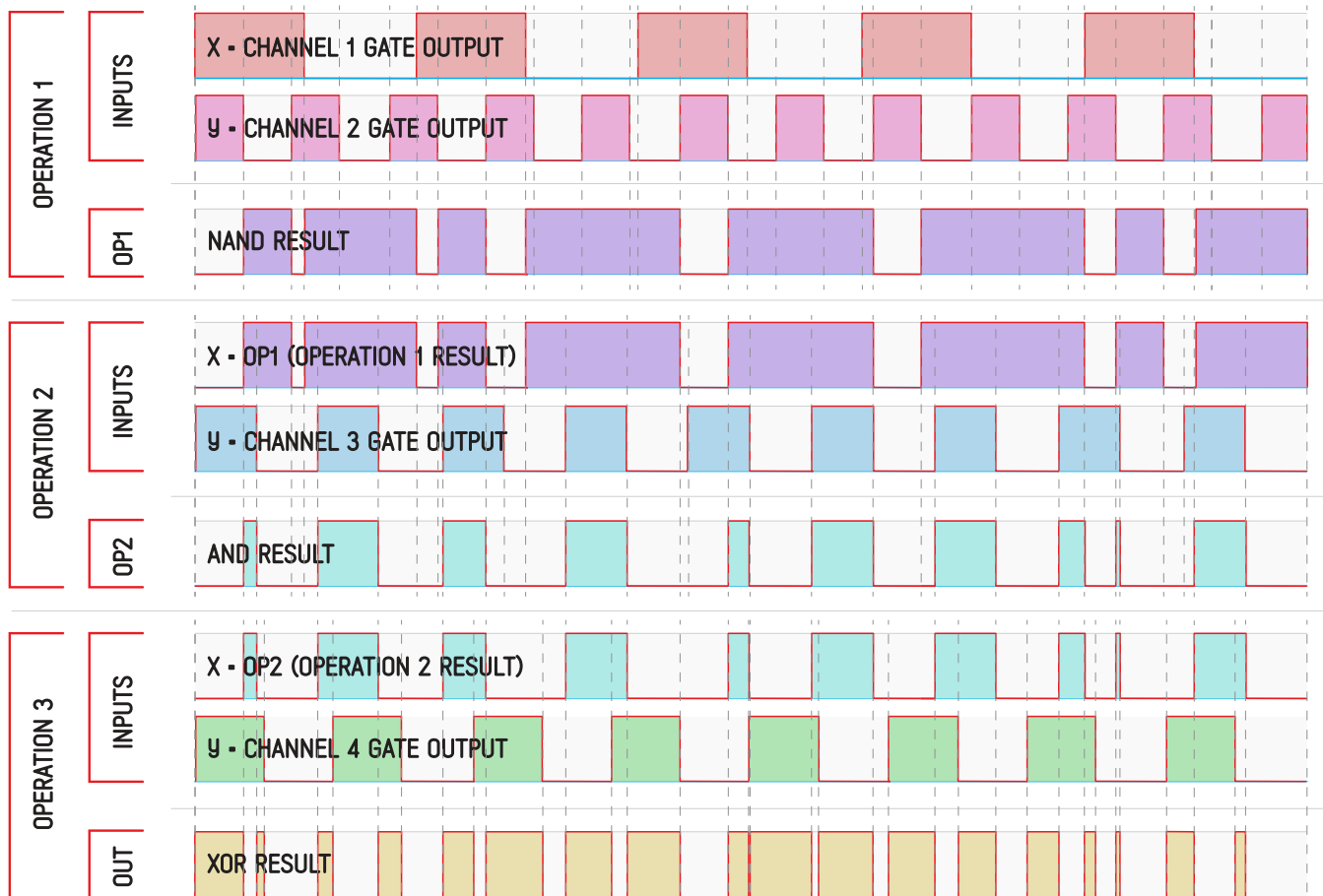

SPECIAL NON-LOGIC ASSIGNMENTS

COUNTER

The counter function allows to output a gate or trigger at every X pulses. Any of the CV inputs, Clock Inputs, CV outputs or Logic outputs can be used as an input.

COUNTER OUTPUT EXAMPLE

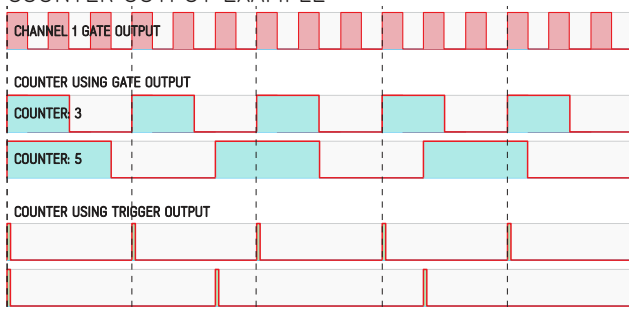

```

LOGIC ASSIGNMENTS          LOGIC 1
OPERATION          >COUNTER
INPUT              GATE OUT 1
COUNTER SIZE      8
OUTPUT            GATE
    
```

CANCEL **ADD**

BPM - CLOCK OUTPUT

The BPM function allows to output a clock signal at a multiplication (up to x 32) or division (up to /32) of the selected channel BPM. This feature can be used to sync other modules to the ADDAC511.

BPM OUTPUT EXAMPLE

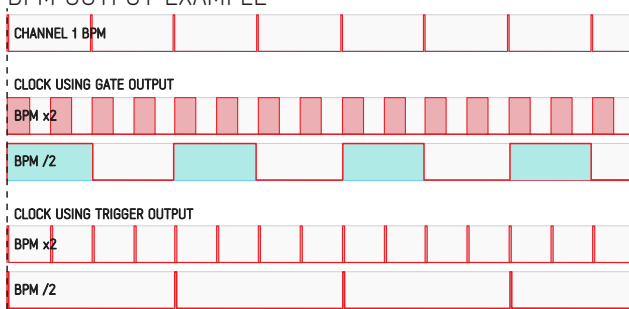

```

LOGIC ASSIGNMENTS          LOGIC 1
OPERATION          >BPM CLK
MULT/DIV          x2
OUTPUT            GATE
    
```

CANCEL **ADD**

MIDI CLOCK OUTPUT

The BPM function allows to output a standard midi clock signal when set to x24, which will output a standard 24 pulse per quarter note midi clock.

MENU

The Menu has 4 features:

- VCO Tuning - Utility program to help calibration of VCOs
- Calibrate CV Outputs - CV Output calibration / mapping
- Screensaver - Extends screen longevity
- Auto Return to Main - Automatically exits to main screen
- Quantizer Rounding - Quantize to closest note, above or below.
- Update Firmware - Enter firmware update process

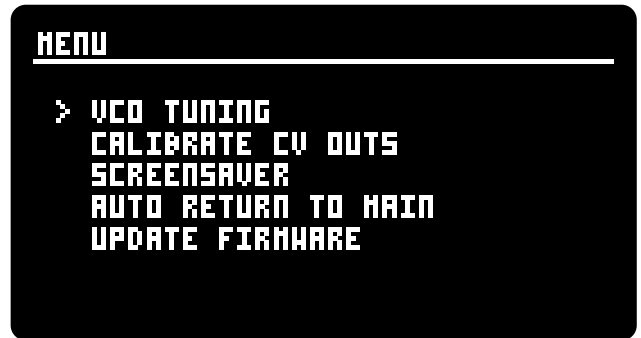

VCO TUNING

This is a utility feature which allows to easily tune VCOs when you're using the 511 as a 1v/oct generator. It will override the main program and force all outputs to the same voltage defined as a musical note. Octave (0 to 4): raises the voltage in intervals of 1v Note (C to B): raises the voltage in semitones

A voltage output monitor and keyboard monitors the parameters selected.



CALIBRATE CV OUTS

This screen allows to easily calibrate the 1v per octave standard. OFFSET: This value offsets the whole CV output in very fine intervals of -0,00076v GAIN: Amplify or attenuate the 1v/oct scaling

CANCEL: Exits the screen without saving.
 RESET: resets calibration to the factory values.
 SAVE: Saves and exits the screen.



SCREENSAVER

The screensaver is used to save the screen life over periods when the modules is not in use. When set to ON the screen will go black after the Wait Time is elapsed and no button is pressed during this time. Pressing any button will exit the screensaver mode and resume the regular screen operation.

Wait Time can be set to: 10 seconds, 1 minute, 2 minutes or 5 minutes.

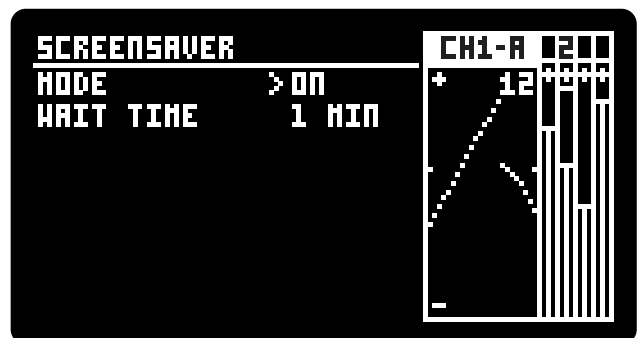

MENU

AUTO RETURN TO MAIN

By default after 30 seconds of physical inactivity the screen will automatically return to the Main screen, this function can be turned ON/OFF.

The user can also define the auto return time: 10 seconds, 30 seconds, 1 minute.



MENU : FIRMWARE UPDATES

FIRMWARE UPDATE INSTRUCTIONS

1. Remove your 511 from your rack while leaving the ribbon power cable connected and the frame On.

2. Connect the module to your computer through the module's back USB connector.

3. Using an up-to-date [Google Chrome](#) browser (you will need at least version 61 or newer) go to this address: <https://media.addacsystem.com/ADDAC511>

4. Press the Connect button on the webpage, notice the list of devices, among the devices list it should show: **"ADDAC511 STOCHASTIC VOLTAGE GENERATOR"**
Do not select the device at this moment.

5. On your module click the [MENU] button and select: [UPDATE FIRMWARE], click [ENCODER B] to enter firmware update mode, after which Press & Hold [ENCODER A]

6. On your browser notice the list will change: **"ADDAC511 STOCHASTIC VOLTAGE GENERATOR"** will disappear and a new device will appear: **"ADDAC511 - FIRMWARE UPDATE MODE"**
Release [ENCODER A], select this new device and press connect.

The firmware update process status can be followed on the browser. Once finished the usb cable can be removed and the module can be placed back in your eurorack frame.

AUTO RESTART

If the device "ADDAC511 - FIRMWARE UPDATE MODE - Paired" is not selected within 30 seconds the module will auto restart and disappear from the browser devices list. If this happen you can repeat step 5 and 6.

WINDOWS TROUBLESHOOTING

If **"ADDAC511 - FIRMWARE UPDATE MODE"** device does not appear in the devices list please follow the steps below:

1. Press <win key> + R

2. Write "devmgmt.msc" in the text box and press OK

This will open the device manager. Under Universal Serial Bus devices check that **"ADDAC511 - FIRMWARE UPDATE MODE"** appears. If the device icon has an exclamation mark, that means the driver must be installed. If you haven't done it before, go to <https://zadig.akeo.ie> and follow the instructions to install it.

After this, follow these steps:

1. Select Menu > Update Firmware

2. While module reboots, keep [ENCODER A] pressed

3. Re-install the driver for the **"ADDAC511 - FIRMWARE UPDATE MODE"** device:

3a. Right-click and select update driver

3b. Select "Browse my computer for drivers"

3c. Select "Let me pick from a list of available drivers on my computer"

4. Select "Universal Serial Bus devices"

5. Select (Undefined Vendor) and WinUSB Generic Device

6. Select YES on the Update Driver Warning

7. Allow module to restart

8. Select Menu > Update Firmware

9. While module reboots, keep Encoder A pressed

10. On the ADDAC511 website refresh the webpage and press the Connect button, the **"ADDAC511 - FIRMWARE UPDATE MODE"** device should now be listed. You can now follow the regular update steps at the top of the page.

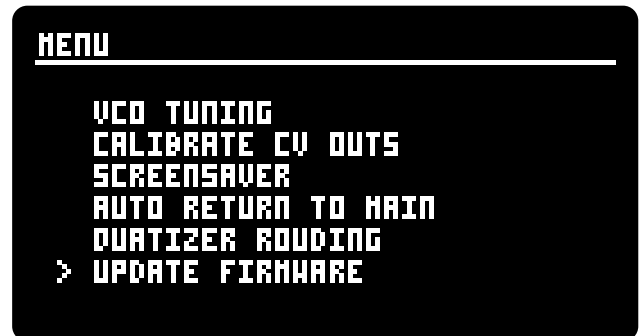

SPECIAL STARTUPS

On power up there are 2 special startups, they can be accessed by Pressing and Holding the highlighted buttons during power up as shown here:

MENU: start with default preset (bypasses previously selected preset)

MENU + STATE C: delete all stored presets

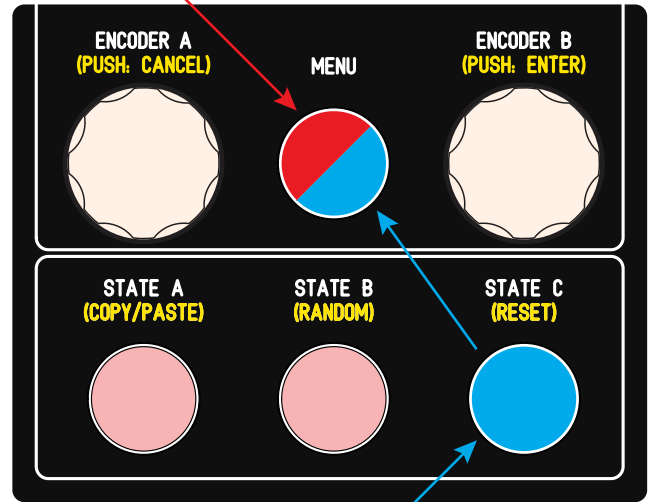

PATCH EXAMPLES

PATCH 1

SIMPLEST FULL RANGE RANDOM VOLTAGE AT 1/4 BEAT

MAIN SCREEN

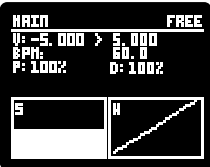

VOLTAGE SETTINGS



TIME SETTINGS

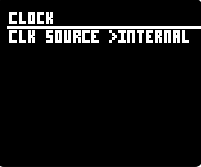
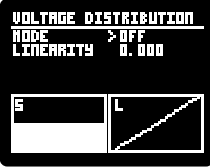
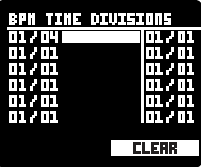
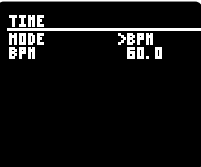

PATCH 2

POSITIVE RANDOM VOLTAGE AT RANDOM BEAT

MAIN SCREEN



VOLTAGE SETTINGS

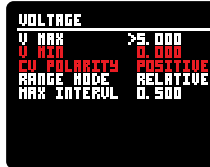

TIME SETTINGS

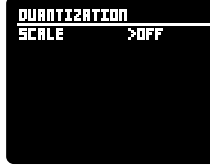
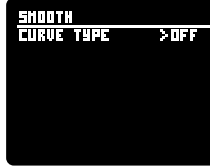
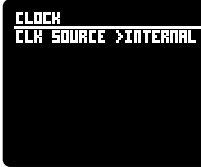
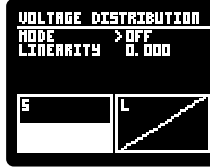
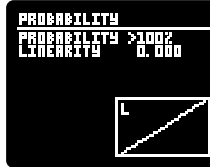
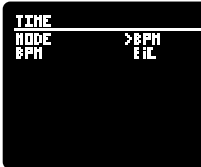

PATCH 3

RANDOM VOLTAGE WITH PROBABILITY AT 1/16 BEAT

MAIN SCREEN

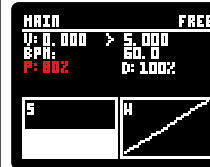

VOLTAGE SETTINGS

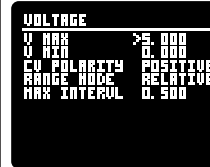

TIME SETTINGS

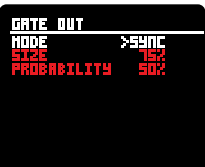
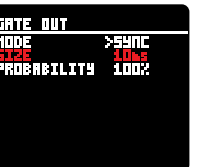
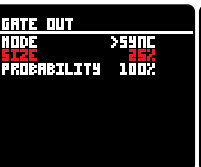
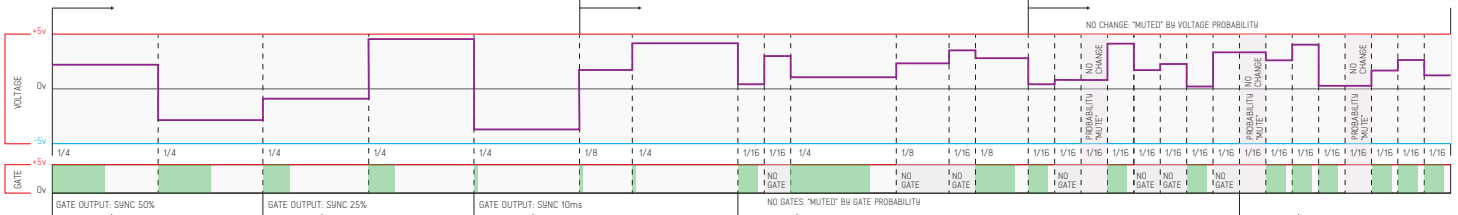
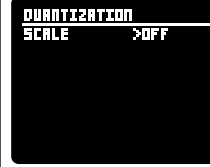
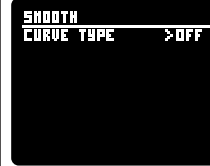
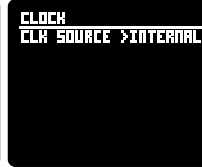
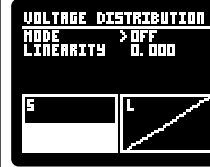
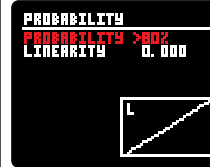
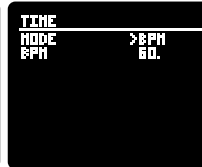

PATCH EXAMPLES

PATCH 4

RANDOM VOLTAGE WITH EXPONENTIAL DISTRIBUTION

MAIN SCREEN

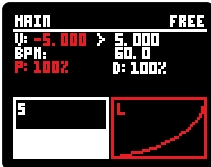

VOLTAGE SETTINGS



TIME SETTINGS

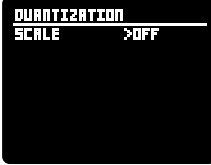
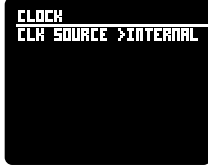
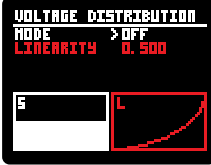
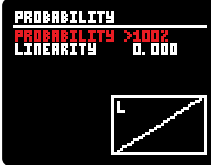
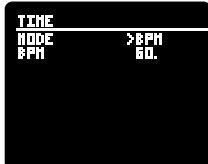

PATCH 5

RANDOM VOLTAGE WITH LOGARITHMIC DISTRIBUTION

MAIN SCREEN

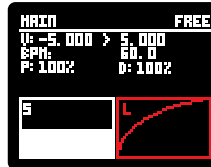

VOLTAGE SETTINGS



TIME SETTINGS

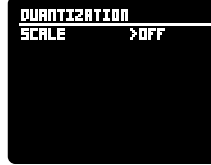
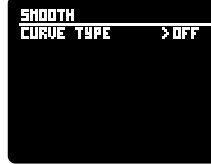
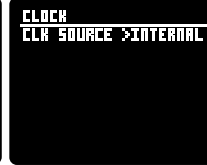
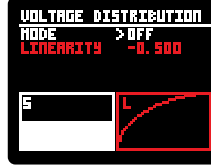
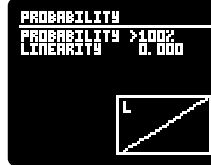
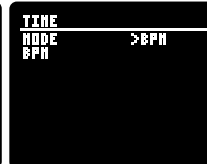

PATCH 6

RANDOM VOLTAGE WITH WALK DISTRIBUTION

MAIN SCREEN

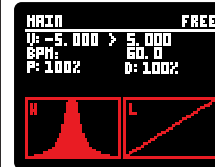

VOLTAGE SETTINGS

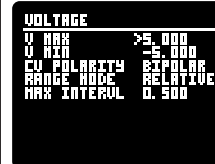

TIME SETTINGS

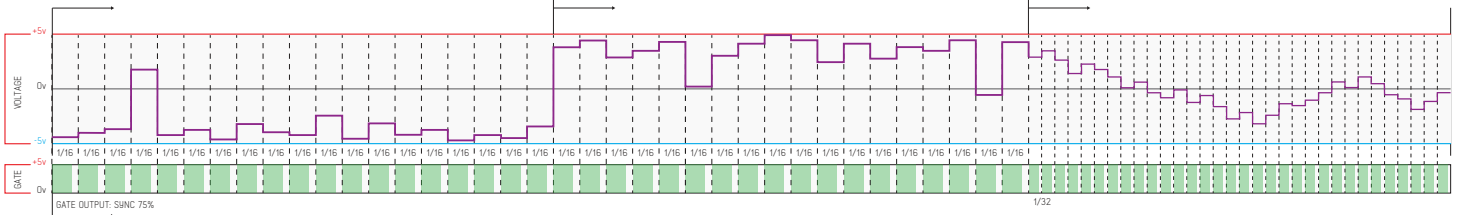
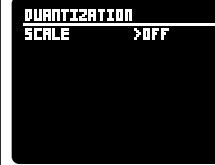
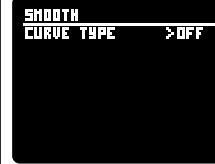
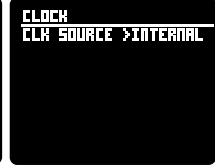
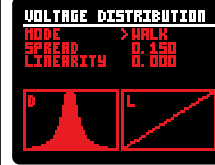
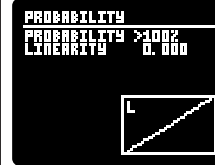
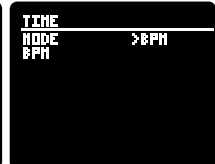

PATCH EXAMPLES

PATCH 7A

RANDOM VOLTAGE WITH WEIGHTED DISTRIBUTION

MAIN SCREEN

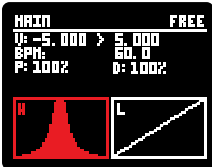

VOLTAGE SETTINGS



TIME SETTINGS

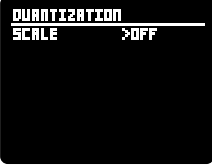
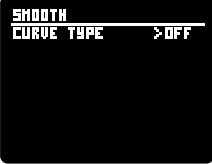
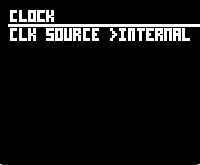
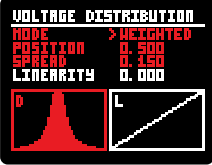
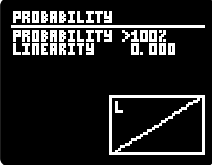
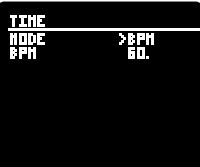

PATCH 7B

RANDOM VOLTAGE WITH WEIGHTED DISTRIBUTION

MAIN SCREEN

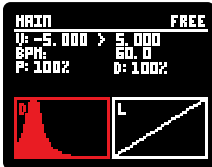

VOLTAGE SETTINGS



TIME SETTINGS

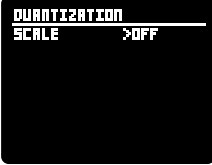
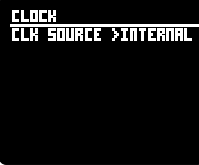
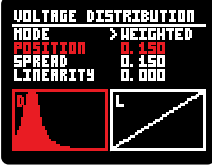
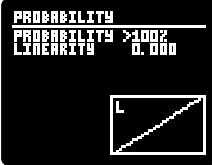
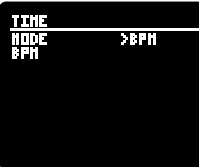

PATCH 7C

RANDOM VOLTAGE WITH WEIGHTED DISTRIBUTION

MAIN SCREEN

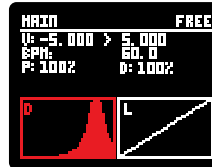

VOLTAGE SETTINGS



TIME SETTINGS

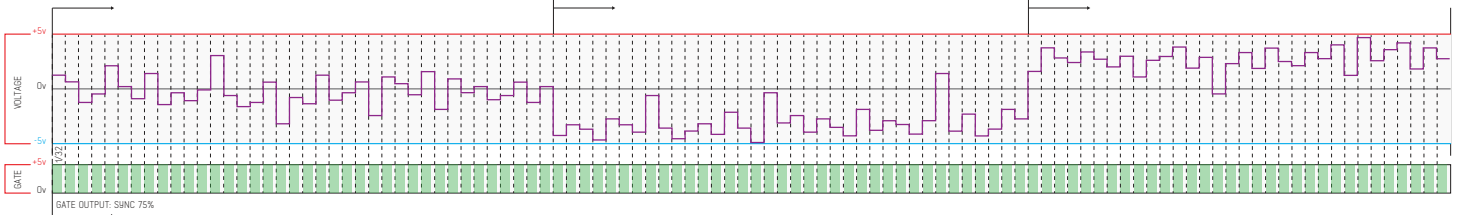
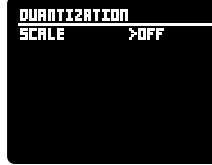
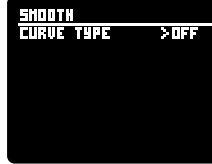
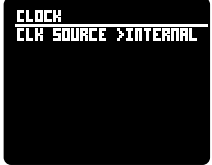
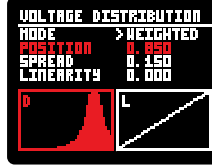
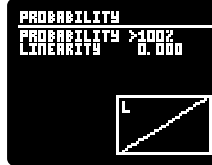
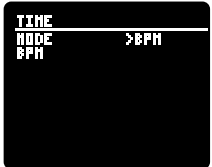

PATCH EXAMPLES

PATCH 8A

RANDOM VOLTAGE WITH LINEAR SMOOTH

MAIN SCREEN

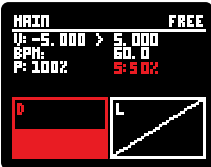

VOLTAGE SETTINGS



TIME SETTINGS

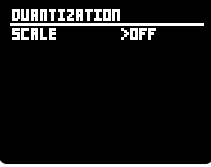
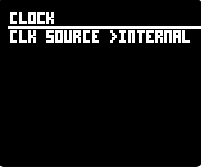
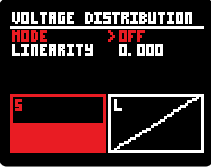
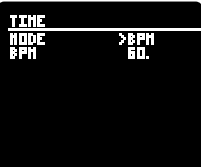

PATCH 8B

RANDOM VOLTAGE WITH LINEAR SMOOTH

MAIN SCREEN

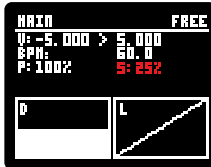

VOLTAGE SETTINGS



TIME SETTINGS

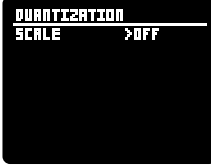
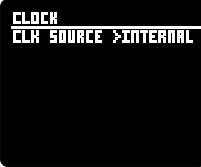
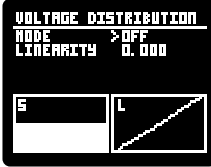
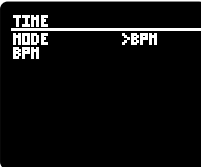

PATCH 8C

RANDOM VOLTAGE WITH LINEAR SMOOTH

MAIN SCREEN

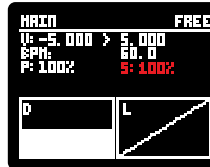

VOLTAGE SETTINGS



TIME SETTINGS

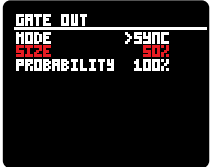
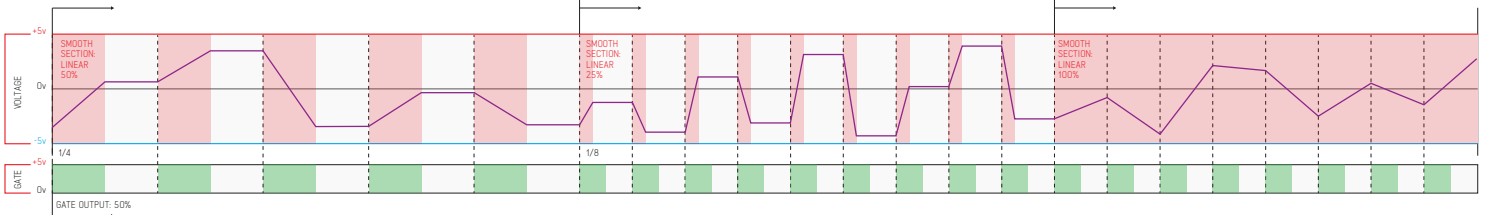
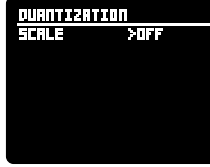
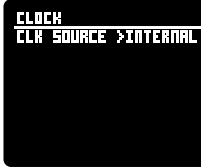
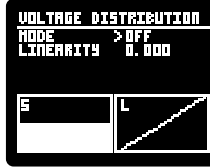
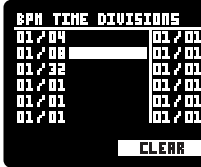
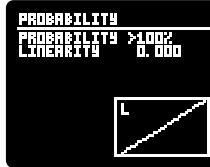

PATCH EXAMPLES

PATCH 9

RANDOM VOLTAGE WITH LOGARITHMIC SMOOTH

MAIN SCREEN

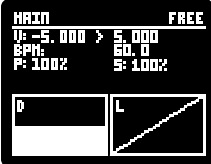

VOLTAGE SETTINGS



TIME SETTINGS

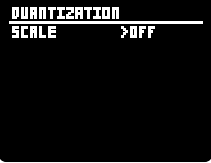
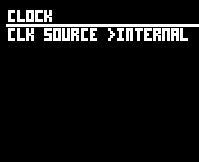
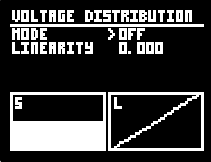
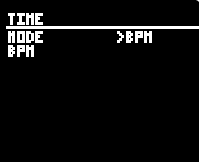

PATCH 10

RANDOM VOLTAGE WITH EXPONENTIAL SMOOTH

MAIN SCREEN

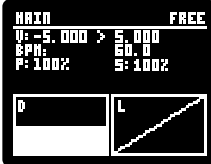

VOLTAGE SETTINGS



TIME SETTINGS

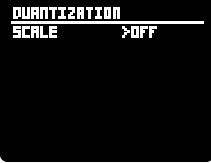
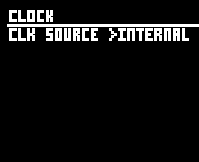
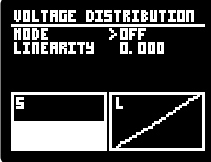
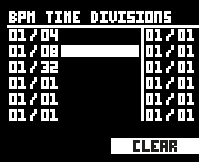
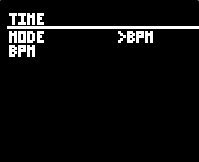

PATCH 11

RANDOM VOLTAGE WITH BEZIER SMOOTH

MAIN SCREEN

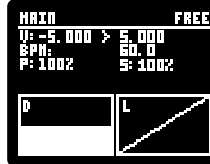

VOLTAGE SETTINGS



TIME SETTINGS

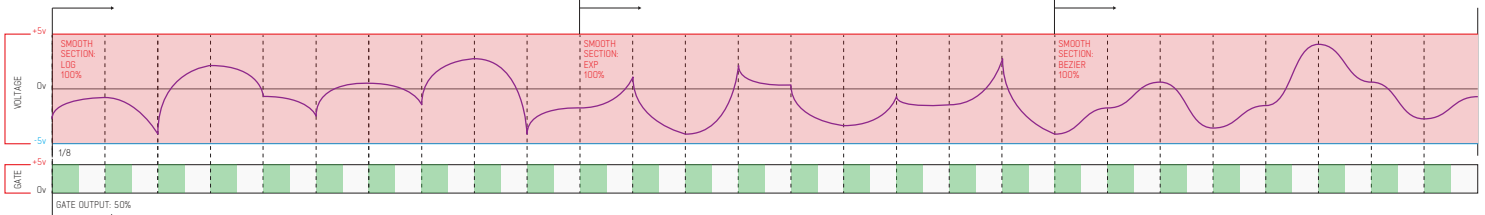
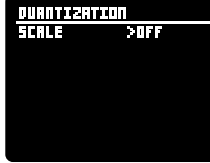
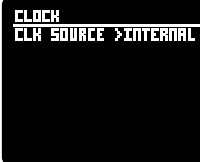
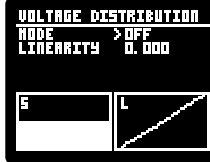
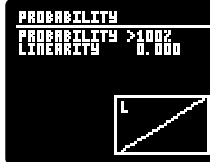
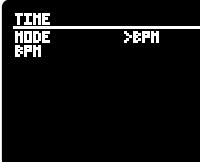

For feedback, comments or problems please contact us at:
addac@addacsystem.com